

# KANSAS

*Wildlife & Parks*

January/February 1994

\$2.25





**GOVERNOR**

Joan Finney

**COMMISSIONERS**

James Holderman, Chairman  
*Wichita*

George Hinch, Vice Chairman  
*Elkhart*

J. Jean Brungardt  
*Hays*

William A. Anderson Jr.  
*Fairway*

Carl Coonrod  
*Elk Falls*

Peg Ann Ranney  
*Dodge City*

Al Ward  
*Topeka*

**ADMINISTRATION**

**Secretary**

Theodore D. Ensley

**Chief of Staff**

Tom Kirker

**Ass't. Secretary/Admin.**

Richard Koerth

**Ass't. Secretary/Operations**

Doug Sonntag

**Director of Administrative Svcs.**

Mike Theurer

**Director of Fisheries & Wildlife**

Joe Kramer

**Director of Parks & Public Lands**

Jerold (Jerry) Hover

**Director of Law Enforcement**

Omar Stavlo

**MAGAZINE STAFF**

**Chief of Public Information**

Bob Mathews

**Editor**

Mike Miller

**Associate Editor**

J. Mark Shoup

**Illustrator**

Dana Eastes

**Photographer**

Mike Blair

**Staff Writer**

Marc Murrell

**Editorial Assistant**

Bev Aldrich

**Circulation**

Barbara Theurer

KANSAS WILDLIFE & PARKS (ISSN 0898-6975) is published by the Kansas Department of Wildlife and Parks, 900 Jackson St., Suite 502, Topeka, KS 66612. Address editorial correspondence and subscription requests to Kansas Department of Wildlife and Parks, RR 2, Box 54A, Pratt, KS 67124 (316) 672-5911. Subscription rate: one year \$8; two years \$15; and three years \$21. Articles in the magazine may be reprinted with permission. Second class postage paid at Pratt, KS and additional mailing offices. POSTMASTER: Send address changes to Kansas Department of Wildlife and Parks, RR 2, Box 54A, Pratt, KS 67124.



7



10

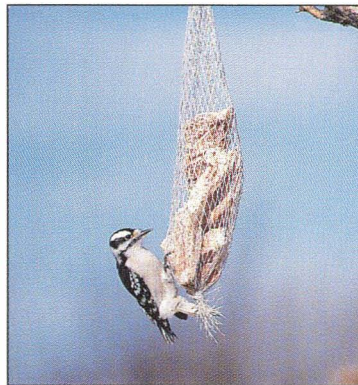

15



**Front cover:** A coyote appears in a sea of grass in response to a dying rabbit call. Mike Blair photographed the arrival with a 400 mm lens, f/8 @ 1/125. **Back cover:** Roadrunners are members of the the cuckoo family and are found in southern Kansas. Blair shot the photo with a 600mm lens, f/5.6 @ 1/250.

**From The Secretary's Desk**  
by Ted Ensley

1

**The Price Of Eden**

Kansas WILDSCAPE is people who want to ensure our wild places are protected for future generations. by Rob Manes

2

**They Eat Rattlesnakes For Breakfast**

The roadrunner is a unique bird that has spawned its share of stories and myths. by Marc Murrell

7

**Calling In Pure Excitement**

Calling coyotes with a predator call is an incredibly nerve rattling experience for any hunter. by Tommie Berger

10

**A Refuge In The City**

Bring wildlife to your back door with the help of this 16-page guide which includes bird feeders, feeds, water, plantings, bird houses and more.

15

**Gallery**

**Clouds** by Mike Blair

31

**Watching Kansas Wildlife**

How to get your own guide to 101 wildlife watching sites in Kansas.

32

**Wild Currents**

Edited by Mark Shoup

33

**Conservation Tree Planting Order Form**

44

**High Ground**

Charlie Horse and Invisible Tom  
by Mike Miller

45



**Editorial Creed:** To promote the conservation and wise use of our natural resources, to instill an understanding of our responsibilities to the land.

**Equal opportunity to participate in and benefit from programs described herein is available to all individuals without regard to race, color, national origin, sex, sexual preference, religion, age or handicap. Complaints of discrimination should be sent to Office of the Secretary, Kansas Department of Wildlife and Parks, 900 Jackson St., Suite 502, Topeka, KS 66612.**



# Tomorrow Is Here Today



As readers of Kansas Wildlife & Parks magazine, you probably enjoy our outdoor photography, natural history and how-to features. As I read each issue, I don't often think of the license sales, budget preparation and legislative appropriations which support not only the magazine but the wildlife and outdoor activities described in its pages.

As Secretary of Wildlife and Parks, however, I am vitally concerned with the financial condition of our resource management and recreation programs.

The reality of the situation is that Wildlife and Parks, like other government agencies, runs on public funds. This includes basic research used to set hunting seasons and fishing limits, park operations, conservation law enforcement and a variety of other programs. Wildlife and Parks has been fortunate because the people who use and enjoy our services have directly supported the agency through license and permit purchases. Many programs continue to be self-supporting, but the time is here when we can no longer provide the expected range of services with our existing funding base.

As we prepare the Wildlife and Parks budget each year, we take a hard look at our existing programs and try to incorporate some promising new initiatives. Funds from wildlife, park, boating and non-game programs along with some State General Fund monies are allocated to support Wildlife and Parks operations. In recent years, our budgets have been lean, but basic services have been maintained. We worried that at some point, this would no longer be possible. It appears that point is here today.

A number of factors have combined to create a very difficult funding picture for all of state government. Wildlife and Parks heads into the new year with the

prospect of a 15 percent budget reduction and the loss of 20 positions. These reductions, if they stand, will result in park closings, the inability to repair flood damage and cancelled programs. I plan to work hard on this issue and hope to restore some funding, but it's clear programs and services will be reduced.

General Fund allocations have traditionally supported about half the operating expenses of our state parks, with the balance coming from park fees. This amount will likely be reduced to about 35 percent in the coming budget year, which begins July 1. We were barely able to operate our system of 24 state parks with past funding levels. With reduced funding allocations, some parks will have to close; not just individual camping areas or access points, but entire parks. It's not clear what other uses these areas might have, but they will no longer be operated as state parks.

Programs will be reduced on the fisheries and wildlife sides as well, particularly in maintenance and improvements to fishing lakes, wildlife areas and wetlands. Hunters, anglers and wildlife watchers may have to deal with reduced access to some department properties as a result.

This is a difficult situation for everyone involved. I hesitate to put this news in an issue filled with photographs and articles about the wonders of nature, however, as stakeholders in our natural resource heritage, I feel it is important you know how serious this situation is.

I hope you will consider these issues as you read the pages of this magazine because this will not be an individual effort. It will take everyone's dedication, creativity and patience to find solutions.

*Ted Ensley*





# The Price Of Eden

by Rob Manes  
*special assistant, operations, Pratt*

photos by Mike Blair

*The Kansas WILDSCAPE Foundation is a private organization devoted to wildlife, wild places and the people who need and enjoy these natural resources.*



The importance of things natural and wild seems reflected in the lack of human decency in places where nature has been trampled by crowded multitudes — where concrete and steel have temporarily subdued the embrace of Creation. Perhaps it's because the crowding itself spawns discontent and strife; or because the absence of surroundings living, green and peaceful renders people unable to consider their own worth.

The more we are without places to be alone in nature's influence, the more it seems we crave its solitude. Unfortunately, the cost of this solitude has outstripped the fiscal reach of many long-standing institutions whose charge it is to provide and protect it. For all of the efforts of government and even some private organizations, the amount of American soil dedicated to (or even available for) such critical uses remains paltry.

Nowhere in the U.S. is the absence of publicly accessible natural areas more conspicuous than in Kansas. On a state map covering this page, the total area publicly accessible for outdoor enjoyment would be represented by a spot not much larger than a penny. So good and concerned people who long for access to the outdoors, for themselves and their children, are often left frustrated and worried. Wild lands and associated wildlife, recreation and learning opportunities slip away.

Not easily dissuaded, however, Americans — Kansans too — are pursuing innovative means of securing the wild places and opportunities so important to the nation's past and future. One such recent effort realizing success is the Kansas WILDSCAPE Foundation — a private organization that brings citizens, government and businesses together for the protection of wild resources.

Established in 1991, WILDSCAPE is a private, non-profit, Kansas-only operation. It pays no affiliate dues to a parent organization and employs no independent fund raising companies. WILDSCAPE is

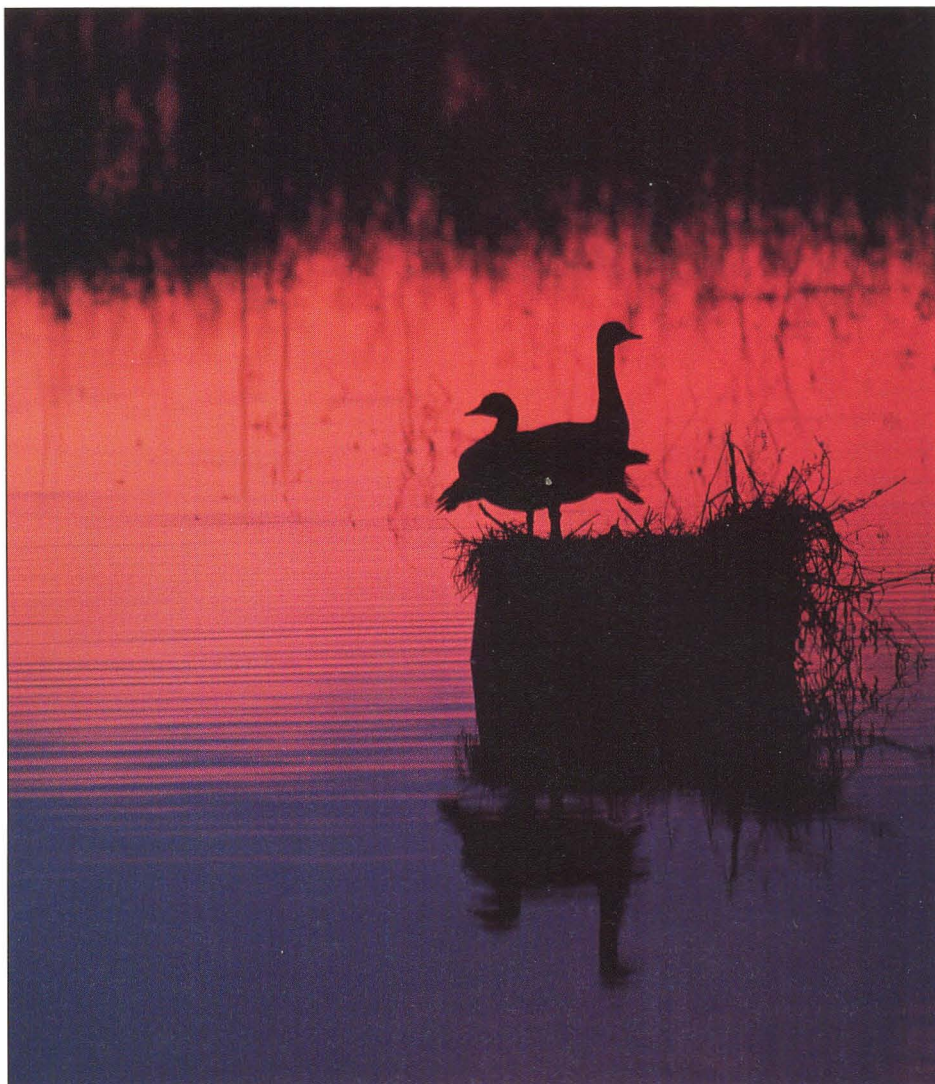

WILDSCAPE provides a unique opportunity for government agencies, commercial businesses and citizens to work together. It also provides innovative, alternative funding methods for natural resource and outdoor recreation projects.

struggling more successfully than most similar organizations through its start-up years, with several major projects already to its credit. WILDSCAPE Executive Director Rich Bailey readily admits that the foundation has not yet "turned the corner" fiscally, but he exudes confidence when predicting that "it's just a matter of time."

Turning the corner will come, in large part, through the influence and networks of WILDSCAPE's carefully chosen board of directors. Each member is selected for his or her stature and credibility in civic circles and long-standing interest in conservation projects. Many board members are corporate executives with recognized clout to generate

financial support for foundation projects.

WILDSCAPE is project-oriented, targeting its fund raising efforts at the completion of individual efforts, each of which must yield distinct benefits to conservation and to outdoor enthusiasts. Many WILDSCAPE projects entail three- or four-way partnerships, involving local citizens' organizations, WILDSCAPE, the Department of Wildlife and Parks and sometimes federal agencies. Such arrangements, established by legal agreements, frequently allow local organizations to operate fund-raising ventures on department lands, while using WILDSCAPE's tax-favored non-profit status. The local organizations



(often outdoor enthusiasts' clubs) use the resulting funds to accomplish predetermined projects, which must benefit the department, its constituents and the resources it manages. WILDSCAPE banks the resulting funds and pays project-related expenses, providing accounting and tax benefits to the affiliated local organizations often called a "friends group." In addition, WILDSCAPE may provide matching monies for the effort, further leveraging state, federal and local funds to accomplish the project.

WILDSCAPE is not a lobbying entity. Like The Nature Conservancy, WILDSCAPE doesn't get involved in the business of influencing legislation or government processes; rather the foundation focuses its resources on boosting conservation and outdoor recreation groups, natural resource education projects and obtaining ecologically important lands. WILDSCAPE particularly seeks land donations — both those that will protect important ecotypes or

provide recreation opportunities and those that will establish year-to-year income, allowing Bailey's corner to be turned.

Bailey characterizes WILDSCAPE as a facilitator organization; a catalyst for getting things done. And so it has proven to be already in its short history.

A current WILDSCAPE project may best illustrate the potential of public-private conservation ventures — a \$175,000 reach for critical information about the effects of the Conservation Reserve Program (CRP, a federal program that retires enrolled croplands into grass cover for 10 years) on upland birds. The research funded through this project will generate clues to perplexing riddles about the effects of wheat farming and CRP on pheasants and other Great Plains wildlife. Though the research has been needed for several years, it was unlikely that the partner states' wildlife agencies in Kansas, Nebraska and South Dakota would have been able to fund it anytime soon. Enter WILDSCAPE and The

Game Conservancy.

WILDSCAPE provided the vehicle for The Game Conservancy, a private British organization, to put \$35,000 with a three-to-one match from the U.S. Fish and Wildlife Service and \$12,000 in services and equipment from the involved states, making possible what was formerly unaffordable. The result will be an extensive study involving radio telemetry and other research strategies to monitor ring-necked pheasant and associated species in CRP and wheat croplands. So unknown is the life history of some involved species that the data gathered is expected to generate as many questions as answers. One of the priority questions that researchers hope to answer is that of why pheasant numbers are recently increasing in South Dakota, but not so much in Nebraska and Kansas. Economic, recreational and environmental concerns fuel the quest.

One of WILDSCAPE's most appealing projects to date involves a partnership with the department



One of WILDSCAPE's most significant contributions is the support it provides to Outdoor Learning Sites (OWLS), a program that establishes outdoor nature classrooms on school grounds all across the state. Thirty-two sites have already been completed.





Another important WILDSCAPE effort is the support and funding it is providing to the rail-trail program. When complete, this project will create a hiking/biking trail in eastern Kansas on an abandoned railroad right-of-way.

and its Nongame Wildlife Improvement Program (Chickadee Checkoff). The effort will bring wildlife education to the Kansas school children. Termed "Outdoor Wildlife Learning Sites" (OWLS), the program is placing specially designed islands of wildlife habitat on school grounds across the state (at this writing 32 approved and about 90 in process).

These natural laboratories are ready-made to enable students to explore the relationships between habitat, environmental quality and wild populations. With WILDSCAPE at the pivot point, the OWLS Program has received support from the U.S. Environmental Protection Agency (\$25,000), the U.S. Forest Service and Kansas Extension Forestry Service (\$10,000), the Florida-based Forrest C. Lattner Foundation (\$2,500), Boeing (\$10,000) and the Kansas Nongame Wildlife Improvement Program. And more private donations may be in the works.

WILDSCAPE is also a partner in

the department's effort to open Kansas' first public trail on an abandoned railroad right-of-way. A stretch of rail from Ottawa to Iola promises great recreational benefits and economic gain for associated communities, but the cost of making the stripped rail bed usable was considered out of reach; that is until WILDSCAPE and some heavy-hitting private partners came along. Those partners include the Garnett State Savings Bank and the Goppert Foundation of Kansas City, Mo. A \$25,000 pledge from the Goppert Foundation and the local bank will help to open the first 17-mile stretch of the trail. Now the \$2.9 million dream is well on its way to reality. This dream is already a reality many times over in other states, where hundreds of former rail miles now host hikers, cyclists and others.

For years a dedicated group of volunteer hunter education instructors has taught their classes at Shawnee State Fishing Lake near Topeka. The shooting facilities there resulted mainly from volunteer

efforts and offered a better-than-usual student training setting. But the volunteers wanted to do better. They wanted to provide a place for classroom-type teaching and a place to store numerous teach aids they have developed and acquired. WILDSCAPE offered the assistance necessary to bring private and public funds together to construct a classroom building.

At Wildlife and Parks' new South Fork Wildlife Area in Cheyenne County, WILDSCAPE is putting to work its legal authority to receive articles of value from the department. An old house and other structures located on the 1,000-acre area offered no advantage to managers or the public. So, the department elected to allow a friends group, operating under WILDSCAPE, to take the house and sell it. The resulting funds will be used to improve the wildlife habitat on the area. Without WILDSCAPE's authority, the sale may have been nearly impossible, and the new wildlife area may have waited years for needed wildlife habitat improvements.

At El Dorado State Park, a group of zealous local business people have formed another WILDSCAPE-affiliated friends group to give life to their vision of new opportunities for park users. That vision includes a greatly expanded amphitheater for concerts, nature education programs and a host of other special events. WILDSCAPE provides the vehicle for the El Dorado group to raise and expend the funds on the state park.

Rich Bailey was hoping for maybe three or four such friends groups to spring up in WILDSCAPE's first year. Already, the list includes more than a dozen such projects in place or in the planning process, all coming forth in the past year. Crawford State Park, Butler State Park, Elk City State Park, Cedar Bluff State Park, Toronto State Park, Prairie Dog State Park and Maxwell Wildlife Refuge — all benefit from the support of WILDSCAPE-affiliated friends groups.

WILDSCAPE isn't exactly pio-





The less we experience the natural world and the less we're able to have nature around us, the more we might need it. Kansas is blessed with tremendous natural resources, and Kansas WILDSCAPE Foundation is devoted to protecting and preserving these resources for current and future generations to enjoy.

neering an all-new field. Similar foundations have been acquiring ecologically important lands and providing public outdoor recreation opportunities for many years in other states. The Iowa Natural Heritage Foundation (INHF), for example, was founded in 1979 by a handful of Iowans who saw the precious remaining natural pieces of their state slipping away. Today that foundation has a permanent staff of 28 professionals and an annual budget of \$2.7 million. Most significantly, the INHF has to its credit 26,000 acres, in 243 land projects, under perpetual protection in what is said to be the nation's most developed state. Most of these properties are now in state or county ownership and open to the public. The Iowa foundation also boasts 350 miles of public trails projects.

The National Parks system has long been the beneficiary of the highly evolved National Park Foundation, which will provide \$2.7 million for NPS properties across

the country. Created by Congress 26 years ago, the foundation is charged with stewardship of private donations to the nation's parks and monuments. It focuses its resources on four major types of projects: 1) education and outreach; 2) interpretive trails, amphitheaters and other facilities; 3) volunteer efforts; and 4) training and professional development for National Park Service employees.

Countless great success stories spring from similar natural resource conservation foundations across the nation, including the Washington, D.C.-based National Fish and Wildlife Foundation, the Trust for Public Land, Michigan's Little Traverse Foundation, Wyoming's Jackson Hole Land Trust and many more. Each one is struggling and succeeding against a tide of ill-planned development, urban-sprawl and public misunderstanding about America's wild resources.

For the countless frustrated

people who hunger for the beauty, solitude and sheer fun of the wild outdoors, the Kansas WILDSCAPE Foundation offers a chance . . . to help, to join, to volunteer, to contribute and to achieve. Theodore Roosevelt summed up the need for organizations like WILDSCAPE when he said "(nothing less than this nation's wartime defense) compares in importance with the great central task of leaving this land even a better land for our descendants than it is for us . . ."

WILDSCAPE is our chance in Kansas.



**For more information about WILDSCAPE, including membership and tax-deductible contributions, please write or call:**

**Kansas WILDSCAPE Foundation  
P.O. Box 4029  
Lawrence, KS 66046  
(913) 843-9453**





# They Eat Rattlesnakes For Breakfast

by Marc Murrell  
*public information officer, Valley Center*

photos by Mike Blair

*You might be surprised to learn that the unique roadrunner isn't an uncommon resident to southern Kansas. But don't blink or you'll miss this prairie speedster!*



What's faster than a speeding bullet, able to leap tall buildings in a single bound, and more powerful than a locomotive? Superman is the right answer, but there is another famous cartoon character that comes close: the roadrunner. Just ask Wile E. Coyote. The real roadrunner looks much different than its cartoon kin, but it runs fast, flies and is tough enough to survive in pretty harsh country. And believe it or not, real roadrunners are somewhat common in southern Kansas.

The greater roadrunner, *Geococcyx californianus*, is the

species found in Kansas and one of two ground cuckoos famed for their running, agility and determination. Their name was derived from their curious habit of running alongside horses and buggies many years ago. However, common nicknames they have picked up since then sound like a Who's Who selection of World Wrestling Federation has-beens: chaparral cock, churea, correo del camino, cock of the desert, ground cuckoo, lizard bird, paisano and snake killer have all been attributed to the speedy roadrunner.

Found mainly in Mexico and the

southwest U.S., the greater roadrunner has been documented in 28 Kansas counties. Its detailed status in Kansas is uncertain, but it's probably a full-time resident in a small number of counties along and south of the Arkansas River. It has been seen in southeast Kansas as far north as Linn and Anderson counties. The roadrunner's typical habitat would include semi-arid areas with scattered vegetation.

Sometimes described as a scrawny brown chicken with a very long tail, the roadrunner remotely resembles a hen pheasant. They are nearly two feet long and are brown with buff streaks. Coloration of sexes is similar.

Roadrunners have strong pale-blue legs and short, rounded wings that show a white crescent patch in flight. Their black beak is strong and heavy, nearly as long as their head. The shaggy, crested head of the roadrunner sports a patch of bare skin behind each eye that is light blue turning orange-red at the rear. Roadrunners' feet have two toes pointing forward and two pointing backward, similar to a woodpecker.

Roadrunners prefer running to escape predators or catch food, but they are capable fliers. They commonly run 10-15 m.p.h. but have been clocked at speeds of 20 m.p.h. While running, their feet barely contact the ground, and their wings and tail aid balance and maneuvers as they stretch out, head forward, tail straight back. No other bird of comparable size can instantly vanish from sight like the a roadrunner.

The roadrunner's food preferences are anything but picky. They devour crickets, grasshoppers, cutworms, caterpillars, beetles, ants, gophers, mice, cotton rats, bird eggs, young birds, lizards, small snakes (including rattlesnakes) and fruit. Scorpions, tarantulas, centipedes, millipedes, and snails are on the more cultured buffets.

Roadrunners food choice of rattlesnakes' has been referred to in folklore. The birds approach the snake cautiously and move slowly,



In the spring breeding season, roadrunners will call from a low perch in a shrub or fence. The call is a dovelike cooing, with each note descending in pitch.





When pushed or while chasing food, the roadrunner will line out, head forward and tail straight back, reaching speeds of 20 m.p.h. A roadrunner can disappear in the blink of an eye, or act peculiarly uninterested in human observers.

almost mesmerizing the rattler into complacency. The bird droops its wings around its body, so that any strike will hit harmlessly on feathers. Then, with tremendous speed and agility, the roadrunner stabs the snake with its harpoon-like beak and beats it on the ground until it's dead.

These truly unique birds are shy and retiring, sometimes perching on fence posts or utility poles. In spring, males go to elevated areas or perches on dead trees or cacti and sing the song of roadrunner love. The low, dovelike call has 6-8 notes, each descending in pitch. Males are territorial with exotic courtship displays consisting of a tail-wagging and complete with food presented to the female. Mated pairs live in their territory year-round, and the bond apparently lasts for life.

Females build a nest in trees, thickets or cacti usually less than 15 feet above ground. The nests are shallow and compact, camouflaged and about 1 foot in diameter. Building materials consist primarily of sticks lined with grasses, leaves, feathers, snake skin, roots and even dry pieces of horse or cow manure.

Nest building usually lasts 3-6 days and begins in early April and may continue through July. Females

lay from 2-12 eggs, but 3-5 is average. Eggs are creamy white or yellowish. Roadrunner parents split incubation duty after the first egg is laid with the female sitting on the nest during the day and males at night. Since incubation starts with the first egg and eggs are laid in 1- to 3-day intervals, the young differ in age accordingly. The first egg hatches in about 20 days.

A pair will often raise two



Nests are usually constructed in trees less than 15 feet from the ground

broods in a year, and three broods have been occasionally observed. Young roadrunners fledge in 17-19 days and can catch their own food on the ground at this time. The young become independent of the parents 30-40 days after leaving the nest.

Roadrunners are fascinating creatures to watch. Their speed, agility and quickness are impressive, and the fact that they remain shy and elusive makes them even more mysterious.

Because of the roadrunner's limited range in the state and its secretive behavior, most Kansans will never see one. The best area of the state to look for roadrunners is the southern row of counties from Cowley County on west to the arid grasslands of Morton County. But the surest way to see a roadrunner is to investigate any report of a "goofy looking hen pheasant" that "runs like a streak." Roadrunners that live around rural golf courses or houses have been known to tolerate people and sometimes allow close approach and observation. If you ever hear of this situation, don't pass it up. Seeing a roadrunner in Kansas is a unique opportunity, unless of course, you have Wile E. Coyote's latest Acme roadrunner catching gizmo. 



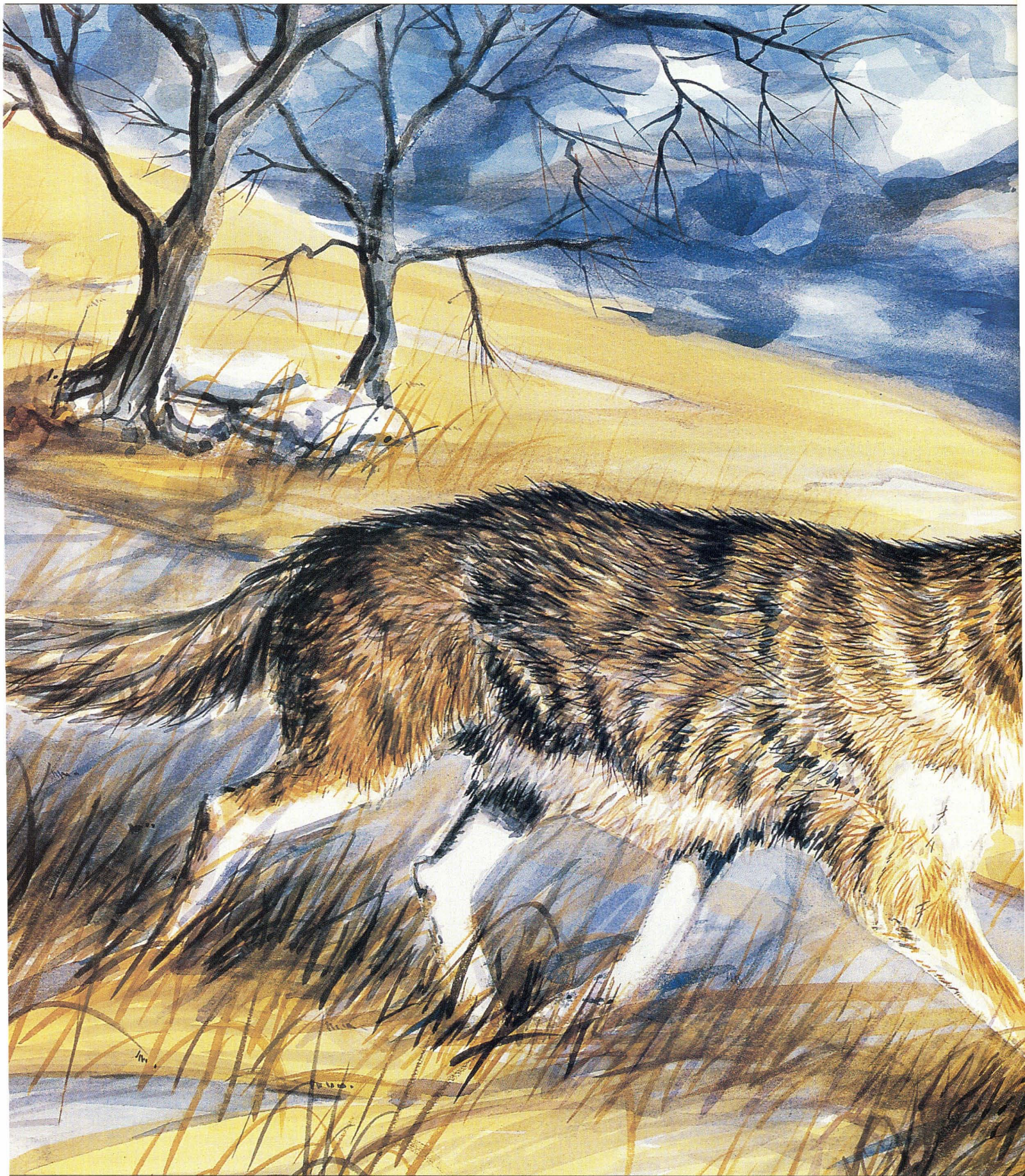



# CALLING IN PURE EXCITEMENT

by Tommie Berger

*district fisheries biologist, Dodge City*

photos by Mike Blair

***Kansas coyotes flourish much to the dismay of livestock producers. Fortunately, predator calling can help control coyote numbers and provide an exciting hunting challenge***

Ken was grinning ear to ear as he rounded the end of my pickup truck. Somehow he knew that we had some coyotes to show him. He beamed even brighter when he counted seven lying in the truck's bed.

Ken's ranch and small feedlot operation located in the shortgrass prairie region of southwest Kansas literally exudes coyotes during the fall and winter. To say that this rancher/stockman doesn't care much for coyotes is an understatement. I had an open invitation to call or trap coyotes.

Stories of brazen coyotes that paraded around the feedlot at dawn and dusk, coyotes that antagonized the ranch hands by sitting on top of round bales near the silo and coyotes hungry enough to commonly eat half the dead steers from the feedlot before the dead animal wagon arrives were almost too much to believe. But on this cool, cloudy, breezy November day, a buddy and I found out how true this rancher's stories were.

Ron and I arrived at the ranch just before first light. We pulled into the feedlot area and, in our headlights, spotted a coyote on top of the round bale near the silo. We laughed at the truth of at least one of the coyote stories we'd heard

about this place. As the dawn sky began to lighten, we spotted a steer carcass along the edge of the alfalfa field. Was that a coyote on the carcass? With a little more light, the one coyote turned into three, and there were two more along the field's edge. We looked at each other and grabbed our rifles. No words were necessary between these two long-time hunting partners.

We each killed one, and the coyotes scattered at the sound of the .22-250s. Although hungry, these coyotes were not dummies. They knew what the sound of a rifle meant, and even the squeal of a predator call couldn't stop them. Still, two coyotes was a fine start to the day.

We'd be back to check this spot again later. We headed north to the pasture and set up in a flat, sparsely timbered draw. With our backs against a dead cottonwood log, we called into the wind. Soon after the second series of dying rabbit squeals, a large male coyote trotted in from the left — Ron's side — dead coyote. We then took the high path up the ridge about 1/2 mile and pulled the truck over the ridge, out of sight to the west. Ron and I walked back over the ridge to the east and set up to call into a finger

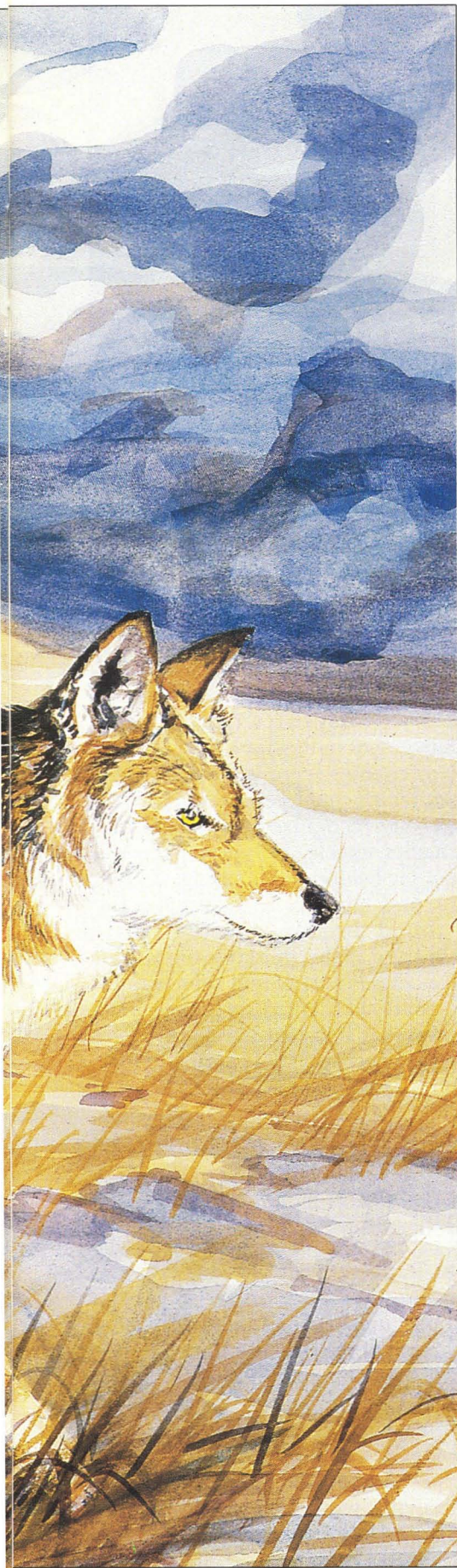

Dana Eastes illustration



draw. After three or four series' of calls on the cottontail, closed-reed call, a coyote appeared in the draw several hundred yards away. But instead of coming in, it leisurely relieved itself and promptly sat down. Whenever you see this kind of behavior, you can bet the coyote either has seen you walk in or somehow made you out. When they sit there and bark, it's like adding insult to injury to the pride of a seasoned coyote caller.

It was my turn to shoot, so I took a good rest and told Ron to back me up. Thank goodness he did because my shot was a shade off the mark. Ron is an outstanding rifle shot, and he anchored the coyote right there.

Another half mile or so up the ridge, we did the same thing — parked the truck over the ridge to the west, walked out on a point to the east and called. After about 20 seconds of calling, I heard Ron say, "Stop," in a loud voice. As I turned my head, the second "Stop!" was more emphatic and was immediately followed by a rifle shot. The coyote rolled dead literally at our feet.

"Where'd that sucker come from?" I asked. "Over the hill from where we just came," Ron replied. Obviously, that coyote didn't know it wasn't supposed to run past a parked vehicle or cross a human scent trail. Normally, when a coyote hits human scent, it's like running into a brick wall — it turns 180 degrees and shoots off in the opposite direction like a rocket.

After several more calls with no success, we decided to return to the feedlot area to eat a bite of lunch and see if any hungry coyotes had returned to the steer carcass. There were none directly on the carcass, but two were sitting on the edge of the adjacent field. Ron cleanly took one of those with a 250-yard shot. By noon, we had six coyotes and only one miss.

As most calling days go, however, we both missed easy shots that afternoon, laying the blame on being tired. We slacked off, drove slower and enjoyed the conversation of good friends. We came to a



Coyotes are remarkably adaptable and clever and have withstood every eradication effort. Problem populations, however, can be curbed by skilled predator callers.

shallow depression on the west side of the ranch where I'd had good calling success in the past. Opening the door to step out, I was surprised when Ron didn't do the same on the passenger side. He claimed he was tired and needed a brief nap, but I wondered if the cheese and deer sausage I'd fed him at noon was disagreeing with his stomach. For this guy to miss a chance to call a coyote, I figured he must have been dying!

But he assured me he was okay and urged me to go alone. Reluctantly, I slipped over the fence and eased across the hill and into

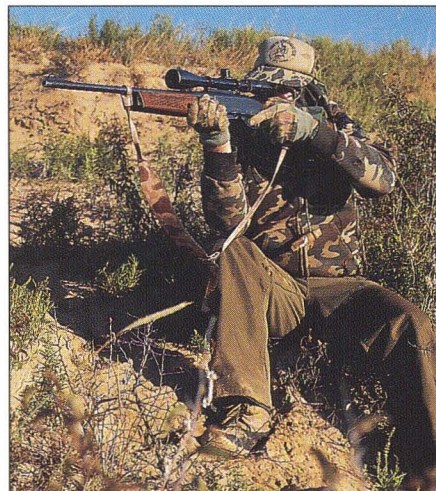

Elaborate camouflage isn't necessary, but set up with a good backdrop. The wind is the most important factor.

the edge of a small plum thicket. Before me was hundreds of acres of closely grazed pasture with a small draw that was choked with sandhill plums. After several notes on the old wooden Circe call, I caught movement in the draw. Not one, but two coyotes were in a foot race to see which could get to supper first. I quickly recognized the leader as a smaller female. The large male was not far behind and gaining. As they turned slightly to reach the flat ground directly in front of me, I shot the male, thinking the female was closer and would offer a quick second shot. I had forgotten, however, that Ron had insisted I try his new Browning bolt action with a bull barrel. Being left-handed and shooting a right-handed bolt action, my second shot was not nearly fast enough!

I lugged the huge male coyote back to the truck, figuring it weighed at least 35 pounds, maybe 40. Ron had heard the shot and was somewhat disgruntled when he found out I called in a double. First double of the day and the only time were weren't both there.

It was still a fine calling day. Seven coyotes out of 11 chances — better than 60 percent success. And the landowner was thrilled, showing what coyote hunting can do for landowner/hunter relations.



That was probably the best November day I've ever had calling coyotes.

Over the years, I've learned that coyotes are more active on cloudy days. Cool days seem to make the sound of the call more intense — it carries better. And you know what windy days do to calling success. Here in western Kansas, perfect days don't come along too often.

Unfortunately, we can't control the weather. Heck, most of the time we can't even predict it. We get outdoors on the weekend, on our vacation or after work . . . we go when we can, so, we must make the best of our opportunities.

While weather may affect your calling success, some conditions make calling coyotes more exciting. Try calling on one those dreary, damp, foggy days. Seeing a coyote, its fur seemingly glowing in the dampness, emerge from a wall of fog at close range will certainly speed up your heart rate. And they respond well to the call in fog.

On one of those foggy afternoons, Ron and I were calling on a large ranch in Comanche County. The visibility was around 75 yards, maybe 100 at best. We simply parked the truck and walked until we couldn't see it, then set up right out in the open. We were familiar with this land and knew the grassy draws in front of us did not have cattle in them.

We called several series', and I elbowed Ron to let him know I'd spotted a coyote in the haze next to the fence line. As I shot, Ron got right on the call, continuing the sequence to cover the sound of the shot. My coyote went down, and I settled back to see if another one would show. Just then, I felt Ron jump and looked around to see a coyote pass by on a dead run at less than 10 feet. When it realized its mistake, the coyote put on the afterburners and proceeded to make like a greyhound, streaking for the fog bank. As I recall, Ron's bullet caught up with it just before it faded from sight.

Another weather condition that can make for good calling is snow.

Have you ever gone out after a fresh snowfall? There are tracks everywhere. Rabbit tracks are usually the most numerous, and not too far behind in abundance will be coyote tracks. Deer tracks will also be common.

But forget about the deer tracks and read between the lines. The rabbits are out and coyotes eat rabbits. Make like a distressed rabbit, and the coyotes are on their way to dinner. The snow-white background makes coyotes easy to spot, but so are you. Put on white coveralls or take along a white sheet (if you can get out of the house with it) or be sure to call from a bush, against a tree or something else that breaks your outline and blends with your camo pattern.

I'll never forget one cold, windy snowy day when two buddies and I went out for a day of calling. Terry was carrying a high-powered handgun, so we worked hard to get a coyote in close. Terry got his coyote about mid-morning, and we proceeded to call with little further success. The day was getting long, and these guys wanted to make one last call. I told them I was wet and cold and ready to quit. They insisted, so at the next stop, I pulled a "Ron."

"You guys go on. It's too damn windy and cold. No coyote in its right mind would be out on an evening like this." You guessed it — five minutes later, as I snuggled in the pickup, I heard the shot. Terry and Glenn came back to the truck with a coyote in tow and both had I-told-you-so grins on their faces. I have never again failed to go on a set if others are willing.

The excitement of coyote calling is enhanced by the opportunities to

learn more about other wildlife while you hunt, and it is an excellent way to scout for deer and turkey. We frequently see deer on calling expeditions, especially when we get way out in the huge pastures and canyons of western Kansas. I'm amazed at some of the magnificent bucks, both whitetails and muleys, we see miles from the nearest creek or tree. During the bow season, you can mix a little coyote calling with deer hunting. In fact, the one and only mule deer doe I've harvested with a bow came to a predator call. And the biggest white-tailed buck I've taken — 154 3/8 typical — was spotted and stalked on a day we were calling coyotes.

I've found lots of good turkey hunting spots while calling coyotes on windy days when calling is more successful in creek bottoms and timbered draws. Some fellows have luck calling with the wind on those excessively windy days, but I can count on one hand the number of coyotes I've taken that way. I'd much rather call in an out-of-the-wind spot on a windy day.

A moderate wind, however, can improve your success, even though the sound of the call won't carry as well. I mentioned earlier that after a rifle shot, we'll hit the call again. This often works, especially in the



Callers may get the heart-racing thrill of seeing a hungry coyote charging directly in. Set up with open ground in front to ensure you can see approaching coyotes.



wind, possibly giving the coyote the impression that the noise wasn't something to fear. On a solo trip to northwest Oklahoma, I was calling over the rolling, sandsage covered hills. After a series of calls, a coyote came in on my left. Although I hate to admit it, it took me three shots to drop it, but as soon as that excitement was over, I immediately called again. Two series later, a pair of coyotes came tearing in from my right, and I dropped both of them, making up for my poor shooting earlier.

It's not uncommon to bring in coyote pairs in late January, February and into March, and if you get into an area where coyotes are concentrated, you might see groups. One morning before work in February, I headed south of town for a couple of quick calling sets. I parked behind an old shed at an abandoned farmstead and moved down the fence line between a pasture and a green wheat field. Weeds along the fence provided cover, and I picked a nice comfortable fence post to sit against, calling toward a big draw to the south.

Not long after I started calling, I noticed movement on the south side of the draw. First one, then two, then three coyotes. Gee, the whole hillside was moving. I rapidly counted seven coyotes all running

to my location. Talk about unnerving! I decided to take the first and closest, then try to get another quick shot or squeal on the call to stop the others. But these were educated coyotes, and none stuck around long enough for a second shot.

Calling coyotes is an exciting pastime, and I can't end this article without a final story about the stampeding coyote. Just a few short months ago, I was in Colorado with an elk and bear tag in my pocket. Bear food was scarce at the higher elevations we were hunting, and so were the bears. So, Steve and I took a day and went to the lower flat country to check out a promising bear spot a local rancher had mentioned. We still hunted down a long, oak brush-dotted draw to find no bears and little sign. At the south end of the draw was a huge, impenetrable tangle of oaks, hawthorn and buckbrush — bear habitat for sure.

The tangle was so thick, we couldn't still hunt it, so I suggested we set up an and try calling. I had a bear cub distress call I was itching to try as well as the trusted Scery predator call. I howled woefully on the cub distress call for three series' to no avail. So, I turned to Steve and indicated I'd try the predator call. I'd barely finished the first series

when off to our right came this stampeding sound. My first thought was a bear at close range, and Steve's first thought was cattle trying to run us over. But it was only a very large Colorado coyote galloping by in front of us at about 10 feet. I swear, it sounded like a herd of elephants going by. We laughed until tears came to our eyes.

You can't call coyotes successfully without spending a lot of time outside. You'll see an awful lot of wildlife and enjoy the beauty of some of Kansas' most wild country. You can also get to know landowners and improve hunters' standing with them by showing you're willing to help in areas where coyotes are a problem. If you show the landowner you're responsible, ethical and friendly, often doors to other outdoor opportunities are opened.

I'm glad that a fellow in Dodge City made me envious years ago. He'd go out to bird hunt, and always bring back a few coyotes to pay for his trip. I skin and finish the hides from all the coyotes I take, and the money more than pays for my trips. For me, there's few hunting experiences more exciting than calling coyotes. 

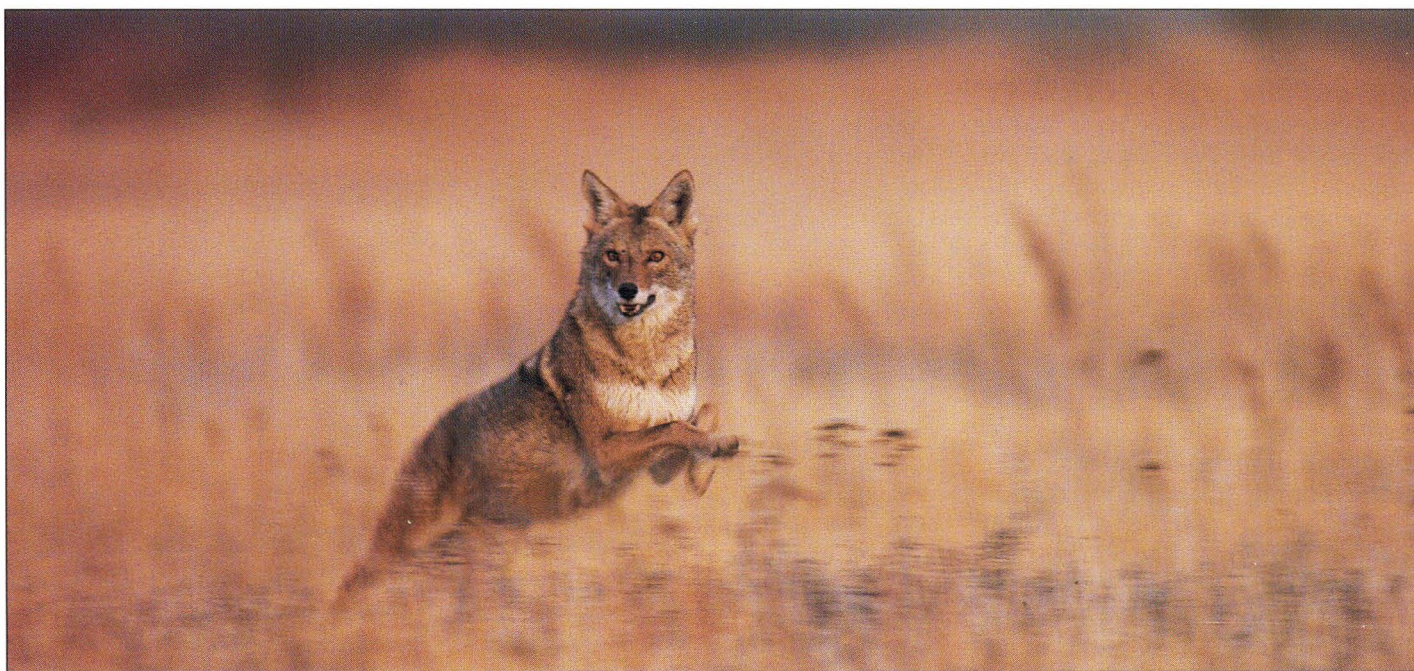



# A REFUGE IN THE CITY

backyard wildlife guide





# Bringing wildlife to your back door

## TABLE OF CONTENTS

<b>Plant A Home</b> Variety, density, and edge are the keys.	2
<b>The Spice of Life</b> Illustrations and plant charts help you find the right planting mix.	4
<b>Feeding Through The Winter</b> Tips for winter feeding.	5
<b>Give Them A Home</b> Dimensions and plans for birdhouses suited to 16 different species.	9
<b>To Quench A Thirst</b> No wildlife planting is complete without a place to drink.	11
<b>Living With Wild Neighbors</b> Of course, not all wildlife is welcome near your home. What to do when problems arise.	13
<b>In the Eye of the Beholder</b> Native shrubs and grasses may clash with some folks' idea of a beautiful yard. What to do if your neighbors complain.	15

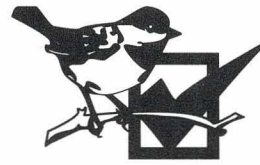

Support wildlife through the Chickadee Checkoff Program on your state income tax form.

**Check for the Chickadee!**

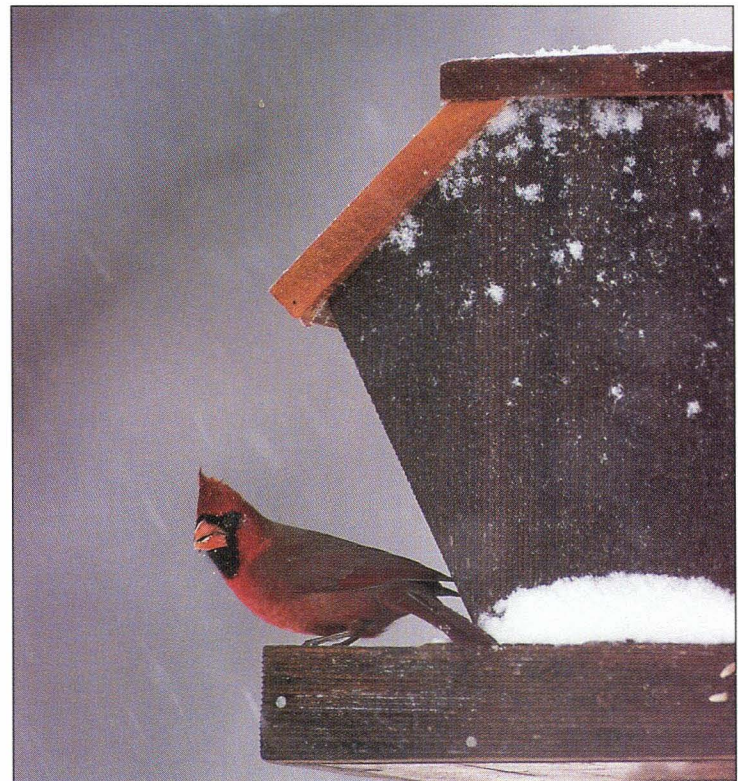

Contrary to popular belief, Kansas is an urban state. According to the latest census, three-quarters of the state's population lives in cities of 50,000 or more. The concept of Kansans as rural people, closely tied to the land, is becoming outdated. But this doesn't mean Kansans have abandoned their inherent love of wildlife.

Both city dwellers and small town folks love watching the antics and activities of squirrels, house finches, cardinals, rabbits, and a variety of other wildlife — right in their own backyard. Many of these urban wildlife watchers participate in the Department of Wildlife and Parks' annual Winter Bird Feeder Survey, sponsored by the

Chickadee Checkoff.

Still others participate in the agency's Backyard Wildlife Habitat Improvement Program, ensuring their viewing opportunities year-round. Through this program, participants are recognized for developing many of the backyard wildlife habitat concepts discussed on the following pages. You can participate by contacting the department's Division of Fisheries and Wildlife at the Pratt office. By filling out an application and sending \$5, Chickadee Checkoff will give you a handsome certificate and a sign to hang on the back porch recognizing your commitment to improving wildlife viewing opportunities in your neighborhood.

Urban wildlife habitat develop-

ment is growing. As people become more isolated from nature, their thirst for "wild" experiences grows. It's not uncommon to see patches of bluestem grass, fragrant sumac hedges, or cedar rows in the middle of suburbia. Buffalo grass may one day be as popular as fescue. For those who would rather see robins and rabbits out their back window than a perfectly groomed — and unoccupied — mat of green, the choice is simple.

If you're interested in bringing wild Kansas to your backyard, read on. There's a world you may never have imagined out there, right in your own back yard. Right in the middle of the city.



# Plant a home



The most dependable way for anyone to take care of backyard wildlife is to create a natural system that enables critters to take care of themselves. Feed a bird in your backyard, and you might help keep it alive. Plant wildlife habitat, and you'll give it a home. Seed- and fruit-bearing shrubs, vines, annuals, and trees not only feed birds, they help produce dozens more, providing places to nest, feed, roost, and escape predators. In return, birds will glean insects from your lawn, trees, and garden and entertain you with their antics, color, and song.

Beyond your initial landscaping, about all you'll have to do is sit back and enjoy the show, year after year. As an additional bonus, all those trees and bushes will increase the value of your property.

Variety, density, and edge are the most important elements of backyard habitat development. Simply put, a greater variety of plants attracts a greater variety of animals. Tall, mature trees attract northern orioles, eastern and western kingbirds, scarlet tanagers, red-eyed vireos, squirrels, screech owls, and other tree-dwelling animals. Shrubs and shorter trees provide nesting sites for robins, cardinals, chick-

adees, grosbeaks, and many more colorful songbirds. Bushes and vines appeal to house wrens, song sparrows, towhees, catbirds, and yellow warblers. Rock walls or rubble piles house chipmunks, lizards, and rodent-eating snakes. Tall grasses serve as nurseries for cottontails and shelter for quail.

Plant variety creates another important element of wildlife habitat — food variety. A good mix of vegetation provides insects for all kinds of birds, and a flower garden can entice butterflies and hummingbirds. Squirrels, jays, and other nut eaters relish mast-producing trees such as oaks, hickories, walnuts, and pecans. Summer birds can't resist cherries, blackberries, and mulberries. Drought-resistant

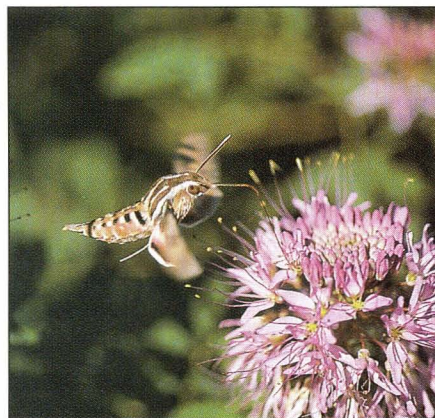

shrubs such as fragrant sumac, Oregon grape holly, cotoneaster, and pyracantha attract a variety of wildlife in fall and winter.

The density of your plantings is just as important as variety. Dense cover is essential when winter winds howl across your yard. When deciduous trees and shrubs have lost their leaves and provide little cover, evergreens provide a cozy refuge. A thicket of juniper, arbor vitae, or cedar makes a snug roost for everything from cardinals to rabbits and even white-tailed deer, if you're close to the edge of town. In fact, cedars may be the perfect wildlife trees for Kansas. Dozens of bird species nest in them — dozens more hide in them — and the nutritious blue berries provide much-needed winter nourishment. A cluster of cedars in a corner of the yard is a good investment in wildlife.

Placement of plants is a factor that must also be carefully planned. For the best view of your wildlife habitat — and the wildlife in it — arrange specimens with the tallest in the back, descending to the shortest closest to the house.

Biologists know that wildlife are found in greatest numbers and greatest variety in areas between habitat types. These areas are commonly called "edge." To create the maximum amount of "edge" in your yard, mix and space your plantings. If you have clumps or islands of dense shrubbery surrounded by open lawn or grass, brush-loving species such as brown thrashers will venture into the open to sunbathe or dustbathe. Open-ground species such as robins will dart into the nearby thickets for protection. You can also create edge by alternating strips of bushes with strips of native grass or open lawn. Plant flowers along the inside edge





# Plant . . .

of your bushes nearest the house to attract butterflies and hummingbirds. Plant a section of grain — such as milo or sunflowers — and leave it standing for winter snacks.

If your yard already has a few mature trees, design additional plantings around them. Shrubs grow quickly and provide excellent summer habitat. Don't trim the lower branches because nesting birds, mammals, and reptiles need them for protection. If your older trees die or have large dead or damaged branches, don't automatically remove them. A dead tree is worth as much to wildlife as a live one. If they don't threaten to fall on your garage or head, allow them to weather naturally, providing nesting cavities for chickadees, woodpeckers, and raccoons. If it becomes necessary to remove a dead tree, consider leaving a stump. Anything from one to 20 feet tall will provide food and housing for a surprising number of animals, especially birds.

Expensive, manicured lawns don't provide much wildlife cover, but native grasses can supply food, cover, and nest sites for cottontail rabbits, toads, lizards, and a variety of insects that birds eat. A strip of little bluestem, big bluestem, Indian grass or switchgrass makes a colorful landscape border or centerpiece. For areas where shortgrass is desired, buffalo grass and blue gramma are natural choices and, once established, require far less maintenance and water than bluegrass or fescue.

Variety, density, edge — the keys to successful wildlife plantings. On the following pages, you will find illustrations, tips, and charts to help you make the right decisions for your backyard wilderness. Happy planting.



## domestics



- alfalfa
- barley
- sweetclovers
- domestic sunflower
- corn
- milo
- Proso millet
- salvia
- daisies

## forbs and native grasses



- Indian grass
- big bluestem
- little bluestem
- switchgrass
- buffalo grass
- butterfly milkweed
- other milkweeds
- all wild sunflowers
- purple coneflower

## vines

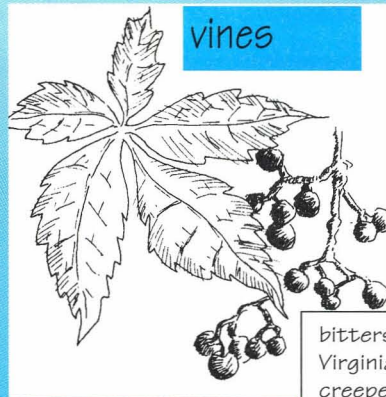



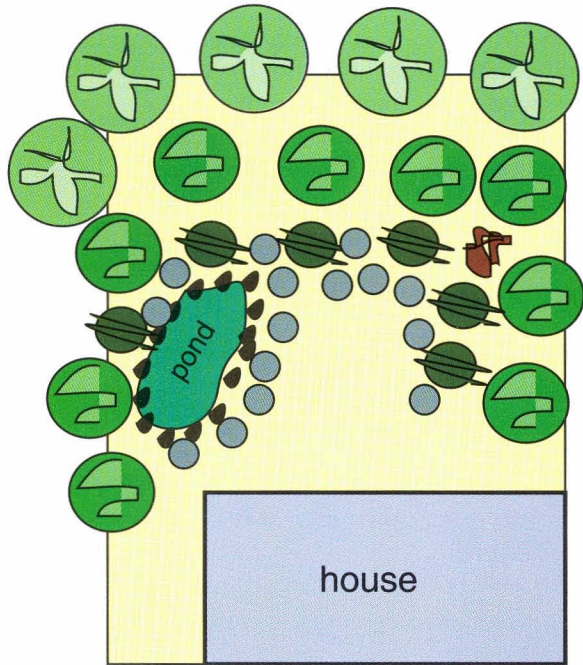

- bittersweet
- Virginia creeper
- any wild grapes
- trumpet vine

- wild indigo
- compassplant
- goldenrods
- larkspur
- penstemons
- gayfeathers
- Illinois bundleflower





**Legend**

-  large trees
-  medium trees
-  bushes
-  grasses and flowers
-  brush pile

Plant large trees to the outside, medium trees, shrubs, forbs and grasses to the inside.

- highbush cranberry
- gooseberry
- golden currant
- cotoneaster
- holly
- firethorn
- wahoo
- sumac
- wild rose
- hazelnut
- dogwoods
- honeysuckle
- autumn olive
- elderberry
- sand plum
- blackberry
- raspberry

**shrubs**

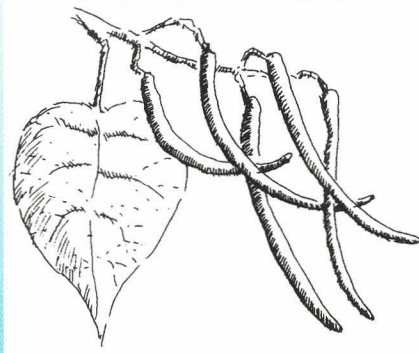

- mulberry
- crab apple
- catalpa
- red haw
- hawthorn
- osage orange
- Russian olive
- black cherry
- choke cherry
- pawpaw
- persimmon
- redbud
- redcedar
- Scotch pine
- Norway pine

**medium trees**

- white oak
- burr oak
- northern red oak
- pin oak
- hackberry
- ash
- black walnut
- pecan
- butternut
- hickories
- sugar maple
- silver maple
- honey locust
- basswood
- sycamore
- cottonwood

**large trees**

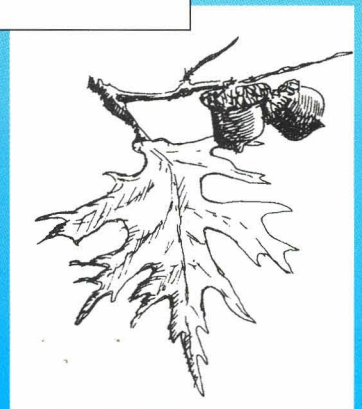





## Feeding through the winter

**W**ild birds and other animals need food, water, refuge from weather and predators, and a place to breed. This is no simple requirement, especially when you try to provide all these elements to a changing array of wildlife through four seasons. Variety is the key to meeting these changing and complex needs. Variety in species — many different kinds of plants offer a continuous, dependable food supply that is not likely to be devastated by disease. Variety in height — many bird species parcel out habitat among themselves according to the height

each prefers; the more levels you offer, the more species you're likely to see. Variety in layout — even in fairly small areas, the amount of edge between major kinds of vegetation is important. Islands and irregular sections of woody vegetation mixed with grass and forbs create more edge and are more attractive to wildlife than simple blocks.

Most people know that the easiest way to attract wildlife is to feed them. Birds are the most popular wildlife to feed, and they're the quickest to respond to your efforts simply because they are both numerous and mobile. A few seeds

and a little suet is all you need to start, and if you live near good habitat such as woods or brushy fields, you could lure a few birds the first day.

The numbers and kinds of mammals you attract also depends on the proximity of good habitat. If you own mature trees, you might soon find a squirrel rummaging through your bird feeder. Cottontails will set up housekeeping in weeds, bushes or even a heap of debris. Near dusk, they'll hop over to sample the table scraps spilled by the birds. If your property abuts a woodlot or other extensive natural area, you can expect nighttime visits from hungry











# Feeding . . .

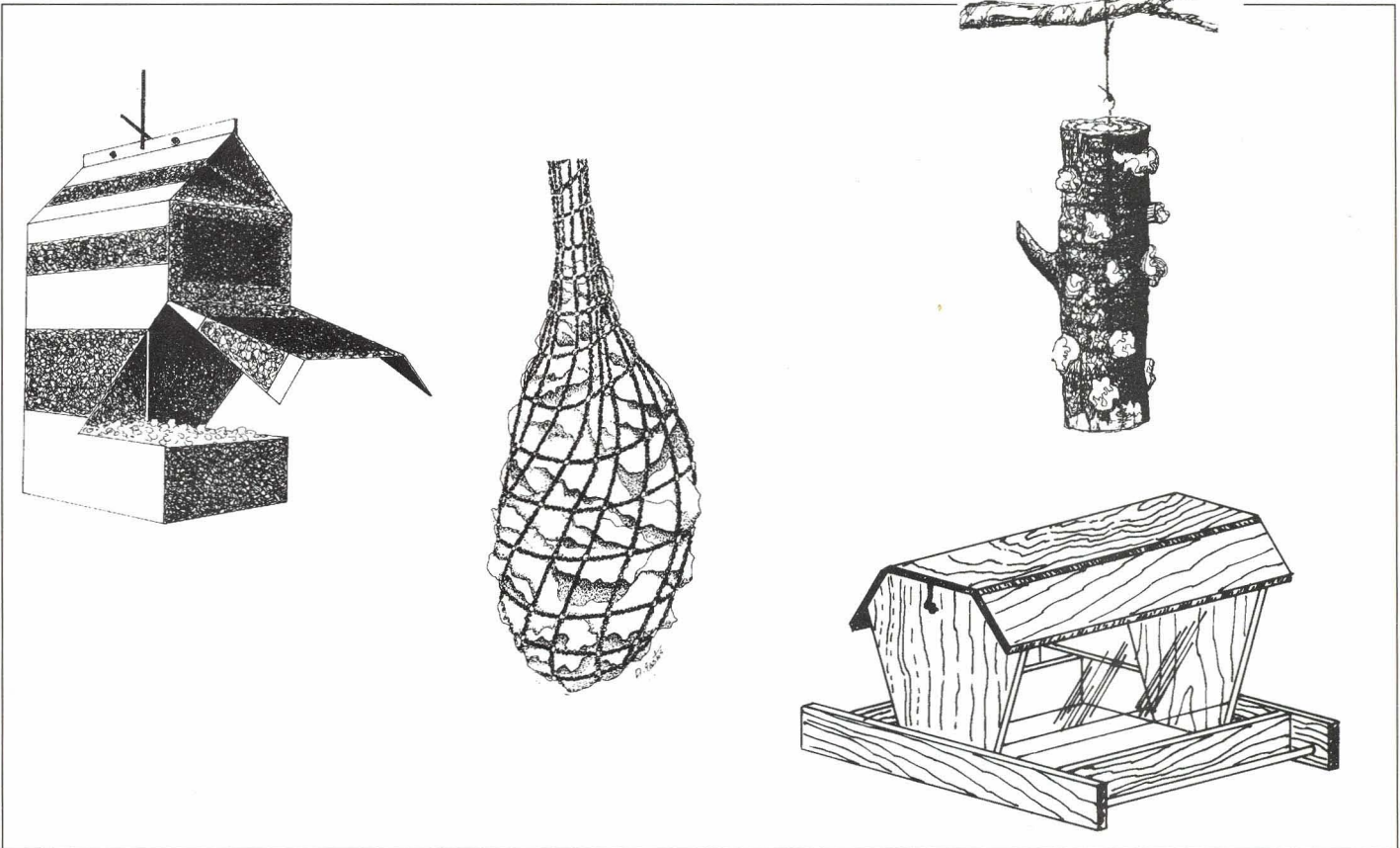

raccoons, opossums, skunks, and even deer.

What you feed and how you feed it are also important. For example, birds that feed on the ground — such as finches, towhees, mourning doves and juncos — won't be attracted to sunflower seeds hung from a feeder in a tree. They'd rather scratch and pick through seed scattered on a bare spot in your lawn. Once they begin foraging regularly, you can build a platform with raised edges to hold the seed a few inches off the ground. This will help keep seed out of the mud. A roof over the structure will further protect the feed.

Swinging feeders are fine for the more hyperactive of tree-feeding birds, but most prefer a stable feeding station. An automatic



hopper feeder that stores a gallon or more of feed and dispenses it as needed will become the focal point of feeding activity throughout the winter. It should be mounted on a sturdy post or tree branch. Heavy metal "T-posts" used for fencing are easy to drive in the ground and can be placed wherever viewing opportunities will be greatest. The feeder will be most effective when placed within a few feet of shrubs, especially evergreens, but not so close that cats and other predators can lie in ambush.

Depending on your point of view and your pocketbook, squirrels can be joy or frustration. They will certainly help themselves to any bird feeder they can reach. If they disrupt your feeding operation, place a squirrel guard over the post just a few inches below the feeder.



## birdfeeder menu (who likes what)

**SUET** — common flicker, downy woodpecker, hairy woodpecker, red-bellied woodpecker, blue jay, white-breasted nuthatch, red-breasted nuthatch, tufted titmouse, black-capped chickadee, junco, tree sparrow.

**SUNFLOWER SEEDS** — white-crowned sparrow, song sparrow, tree sparrow, Harris' sparrow, cardinal, purple finch, house finch, junco, goldfinch, pine siskin, black-capped chickadee, tufted titmouse, red-breasted nuthatch, white-breasted nuthatch, blue jay, red-bellied woodpecker, hairy woodpecker, downy woodpecker.

**PROSO MILLET** — white-crowned sparrow, song sparrow, tree sparrow, Harris' sparrow, purple finch, house finch, junco, goldfinch, pine siskin.

**CRACKED CORN** — white-crowned sparrow, song sparrow, tree sparrow, Harris' sparrow, cardinal, purple finch, house finch, junco, goldfinch, white-breasted nuthatch, blue jay, red-bellied woodpecker, common flicker.

**THISTLE** — purple finch, house finch, goldfinch, pine siskin.

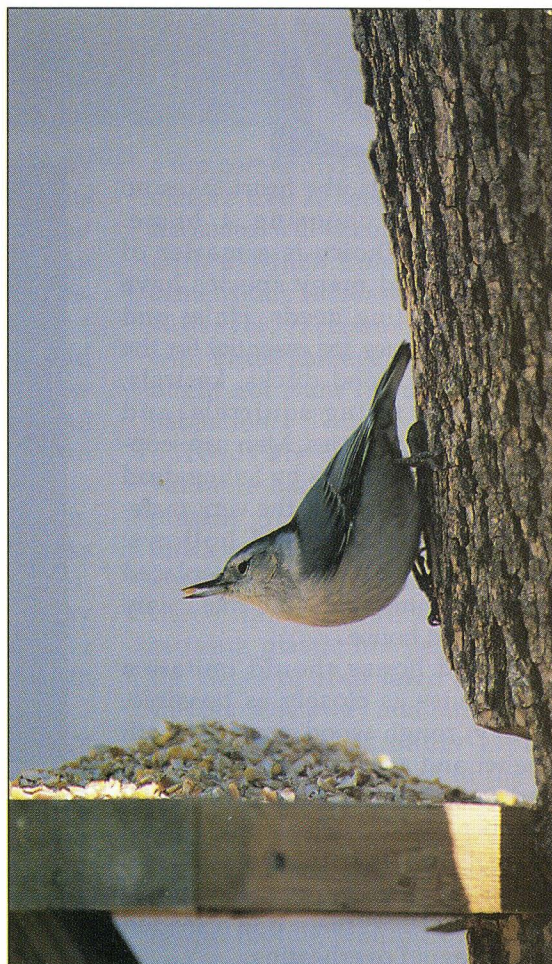

Commercial guards are available, but a garbage can lid or other metal disc balanced on a metal stop or clamp should do the trick. If you really enjoy watching squirrels but just want to keep them away from your bird feeder, skewer an ear of corn to a nail driven in a tree or post.

When it comes to seed, it's hard to beat sunflowers, especially the solid black oil-seed type. They're inexpensive, packed with protein, and relished by the more desirable songbirds. Starlings and house sparrows seldom take them, but house finches love them. Combined with millet, another inexpensive grain, you have a near-perfect mix. Both can be purchased at most local grain elevators in 40- or 50-pound bags.

Suet (animal fat) is an important winter food for insect-eating birds. Get beef suet from your local grocer

and hang it in plastic mesh bags from tree branches. You can also press it into holes bored in a log or place it in a wooden cage. (The one drawback of suet is that it attracts starlings.)

Although not necessary, occasional raisins, apples, and other fruits will enhance your feeding operation.

In summer, many bird watchers like to hang hummingbird feeders. Under natural conditions, hummers may take some insects, but their primary food source is the nectar of flowering plants, such as trumpet vine. This part of the diet can be supplemented with sugar water. In the past, honey was recommended, but honey can cause a variety of health risks to these tiny birds. Sugar water should be prepared in a one part sugar/four parts water solution and boiled, then allowed to cool before serving.

Although reports vary, it is recommended that hummingbird feeders be taken down before cold weather sets in, usually by October, to encourage a timely migration.

Whatever your feeding setup, keep the operation clean. Periodically clear feeders and feeding areas of droppings, which can spread disease.

Birds and other animals survived winter on the Great Plains long before man's arrival, so feeding is not necessary. True, it can help some individuals survive particularly harsh winters, but the primary benefit lies in the pleasure it gives humans. It also increases our awareness and appreciation of nature, and this attitude enhancement may benefit wildlife in the long run. Another bonus to humans is that birds will glean insects from your lawn and garden, reducing the need for chemicals.





# Give them a home

For animals, the heart takes no part in choosing a home. Home choice is a matter of function, and many species have specific nesting needs. Holes and hollows in trees are essential for the survival of wood ducks, kestrels, bluebirds, flying squirrels, and dozens more species. Man can jeopardize cavity nesters by felling dead branches and trunks, the very materials needed for good hollows. Fortunately, these can be replaced with a common artificial tree cavity — the bird house.

A bird house should imitate a tree cavity as closely as possible. Heavy, rough wood provides both shelter and a rustic look. Cedar and redwood won't deteriorate like cheaper woods such as pine. If you want to protect the bird house, finish the outside only. If you use metal or plastic, place it in a shaded area to avoid overheating.

The size of the entrance hole and its distance above the floor are important in keeping predators out. For instance, starlings will reach into shallow bluebird boxes and peck the young or adults to death. Follow the dimensions given in the accompanying chart. Don't put dowel rods or other perches beneath the entrance hole. Cavity nesting birds don't need them, but pests such as house sparrows can use them as harassment platforms.

Cut the roof larger than the box and slant it forward so it sheds rain away from the hole. Hinge the roof, floor, or one side so you can remove old nests immediately after a brood has left the nest.

If predators are a problem, mount houses on posts or poles rather than in trees. Some snakes, raccoons, and house cats will rob nests if given the chance. A guard on the post below the house will keep most predators out. For blue-

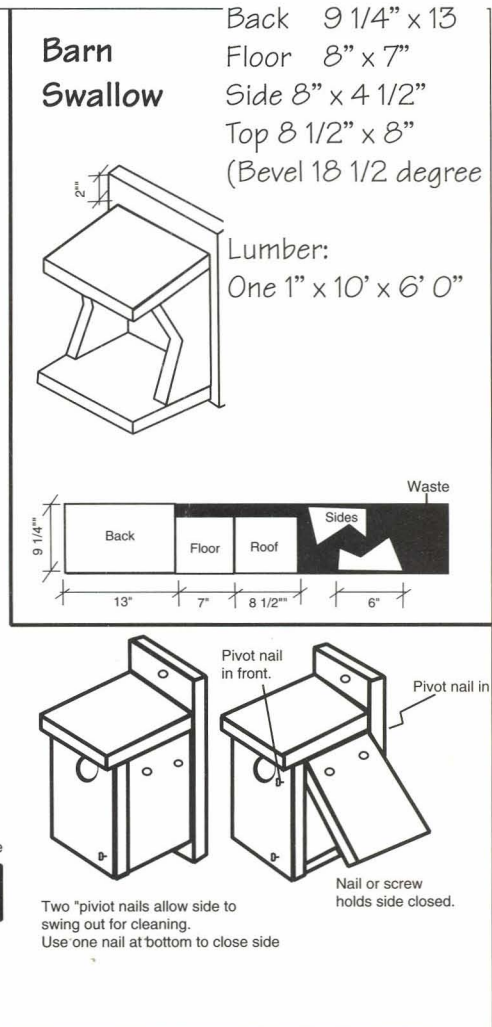
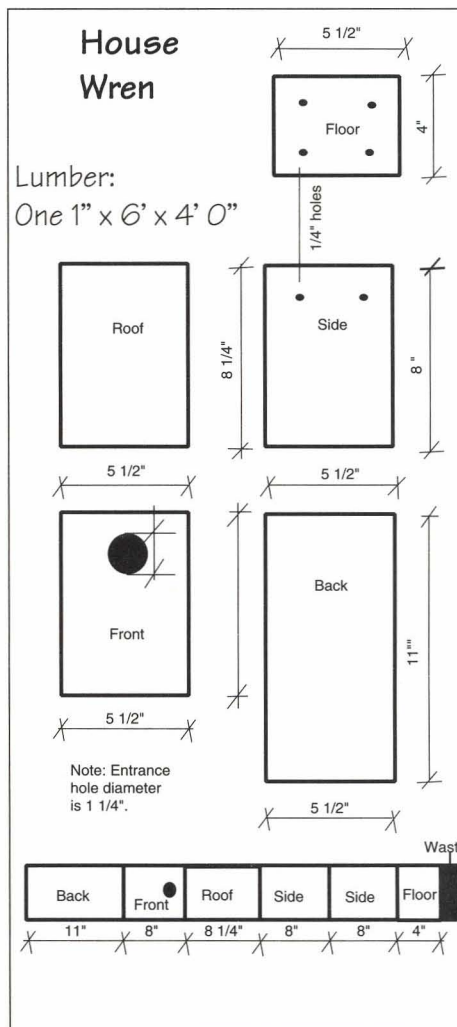



birds (which are mainly a rural or suburban bird), a one-half inch wire mesh screen around the hole is often recommended.

When placing a bird house, face the hole away from prevailing wind and toward brush or branches that fledglings can fly to. Place wood duck boxes over or near water. Put barn owl boxes in large trees or high on the outer walls of buildings or silos. (The barn owl is a great ally

### Purple Martin

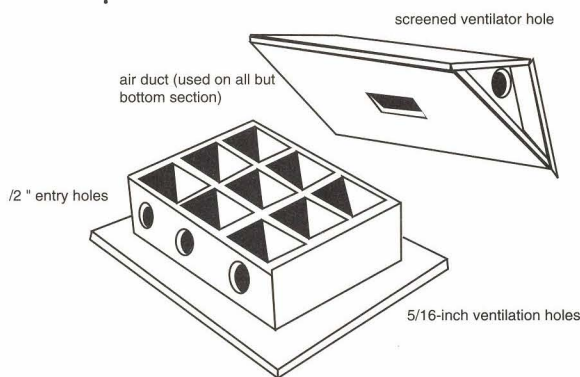

of the farmer: a large brood may consume as many as 1,000 rodents in nine weeks.) Shelves mounted under building eaves may encourage barn swallows, pheobes, or robins to nest.

For woodpeckers, owls, and kestrels, place a soft layer of sawdust in the bottom of the house. All other birds will bring their own nesting materials.

Mammals are easy to build for.

For chipmunks, just pile rocks or rubble in an odd corner, being careful to leave many cavities. You can also cover small tiles, boxes or cans with rocks.

Tree squirrels readily accept man-made boxes. In fact they often commandeer wood duck boxes. A squirrel box should be 20 inches deep, 10 inches front to back, and 6 inches side to side. Cut a square, 2 1/2-inch entrance in

a top corner and secure the box in a mature tree 20 feet off the ground. Raccoons will occupy a similar box with a 4-inch hole and all other dimensions increased by 6 inches. However, raccoons wreak havoc with birds, garbage, and crops. You might not want to encourage their habitation.

Toads are both interesting and valuable backyard wildlife. They present great educational opportunities for kids, and they eat lots of insects. You can provide harbors for these familiar amphibians by burying plastic margarine tubs at the edges of your lawn or garden. Cut one side away and bury slightly just a few inches under ground, leaving a short runway to the surface.

Insect-eating reptiles such as ribbon snakes, garter snakes, and fence lizards will room in rock heaps, rooting stumps, brush piles, and stone fences.

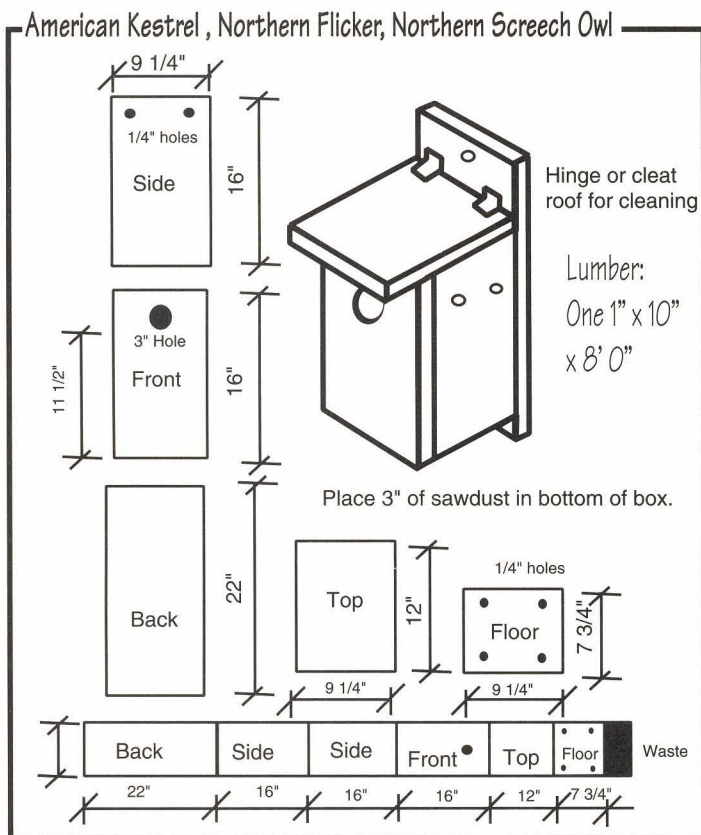





## To quench a thirst . . .

Every type of terrestrial habitat, including your backyard refuge, is more attractive to wildlife when it has a steady water supply. Anything from an upside-down garbage can lid to a multi-level series of ponds connected by recirculating waterfalls will work,

and you can make it more than just a bird bath. A backyard pool can be home to bullfrogs, fish, turtles, and even wild ducks, depending on your ambition and space.

For a safe and attractive water-hole, make it shallow, one inch deep or less, so small birds can stand in it

and bathe. If you build a large pool, make one end of it this shallow. Place a rock in the middle as a safe loafing area for frogs and birds. The sides should be low and gently sloping so small animals can climb out, and the pool or waterer should be in shade so it stays cool.

A noisy dripping faucet is great for attracting small birds

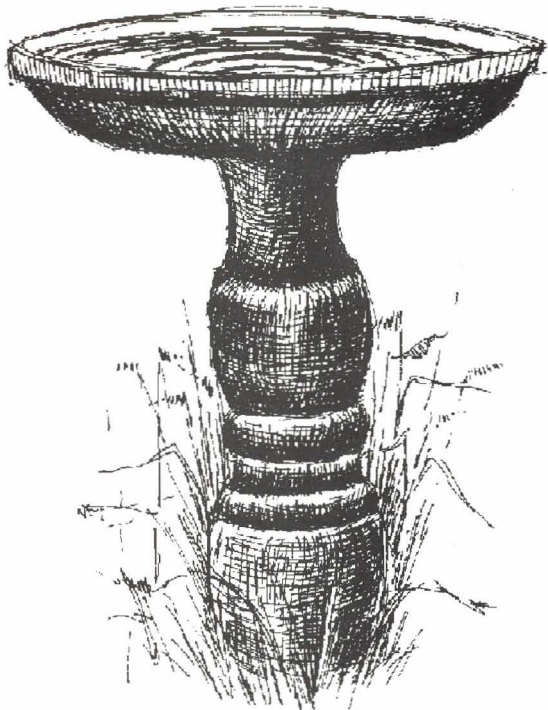
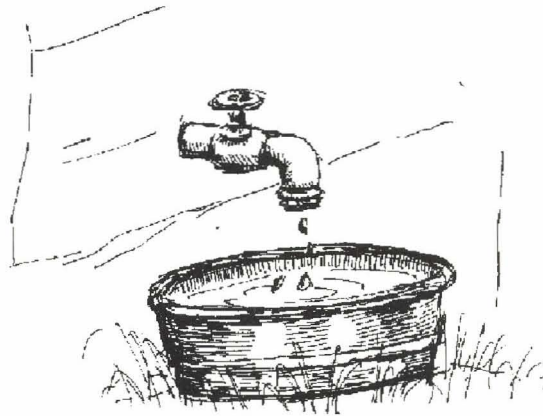

Commercial bird baths

Commercial water sources are available at farm supply stores

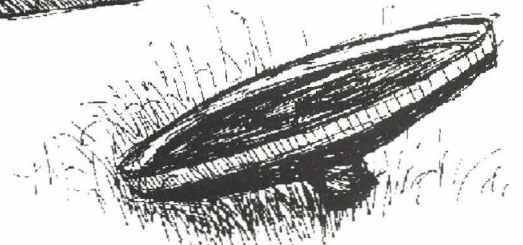

Upside down garbage can lid



The sound of moving water will attract wildlife as quickly as anything. If you don't want to invest in an elaborate and expensive circulating pool, hang a leaking bucket of water over your bird bath or suspend the end of a hose over the water and let it drip. A foot-deep pool or series of pools highlighted

with a few lilies, arrowhead plants, cattails, and other water plants will compliment both your landscaping and your wildlife plantings. The more vegetative cover and diversity near the pool, the more valuable it will be. Insects will live in the vegetation and provide food for frogs, salamanders, birds, and even bats.

Hardware stores and bird feeding supply shops sell circulating pumps to keep the water fresh. You'll have to import a few fish and amphibians from a nearby stream or pond, but return them before winter sets in. Keep a portion of your pool open in winter with a livestock trough warmer.

Illustration from National Wildlife Federation's book *Gardening with Wildlife*

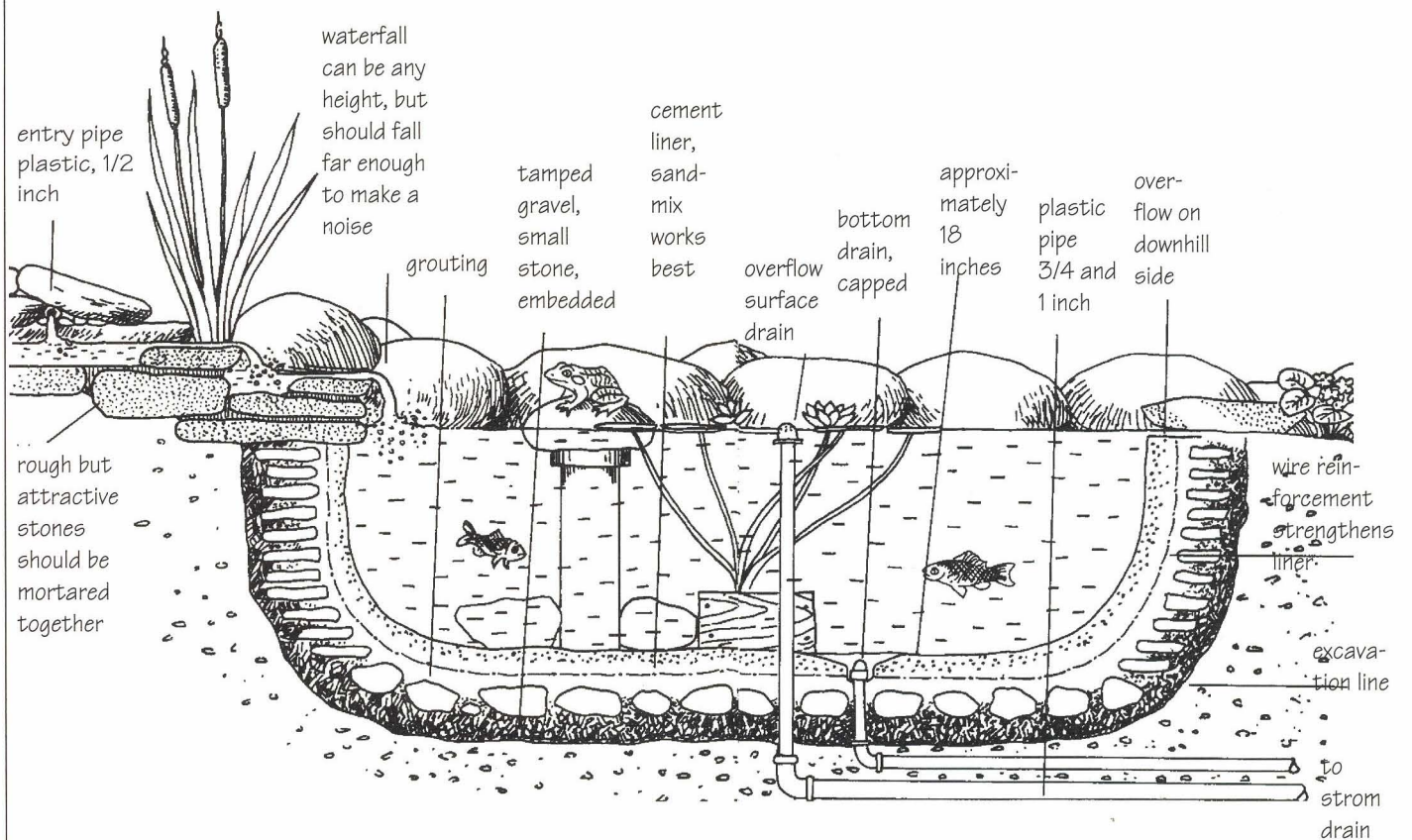





# Getting along with wild neighbors

**H**aving wildlife watching opportunities out your living room window is an indescribable pleasure, but attracting wildlife can occasionally be a mixed blessing. Everyone enjoys the cardinal's song and the squirrel's acrobatics, but no one likes the smell of skunk or the sound of a raccoon knocking over a garbage can in the middle of the night. Yes, it's easy to understand that skunks and scavengers are only seeking

shelter or a decent meal. Nature has a design for all creatures, but knowing this doesn't help when you're trying to get some sleep.

Here are a few tips for dealing with or avoiding critter problems. If these techniques fail, call your local animal damage control officer. A number of live-traps can also be purchased.



## Skunks

Normally, skunks eat insects, rodents, and wild fruit, but they can do real damage to a garden. Under a porch or foundation, they can create a real air of tension. So how do you fight something you don't want to get near? Mothballs is one way. Slip a box into their den and scatter them around the plants you want to protect. (Never do this if small children may enter the area! Not recommended for crawl spaces or other places venting into living areas.)

Never approach a skunk or other mammal. If it is acting strangely in any way, report it to the local police.



## Raccoons

When protected in suburban settings, raccoons quickly learn to exploit the man-made environment, making dens in garages, dog houses, and chimneys. They learn to open locks and gates, manhandle garbage cans, and steal cat food off the back steps. Sometimes they even steal the cat. If you don't want coons, don't supply them with den sites, and try to limit food supplies. If they find your garden, try leashing a dog nearby at night. A radio blaring through the night or an electric fence about six inches off the ground might also help.



### Sparrows and starlings

These two European immigrants often out-compete desirable native species for food, and starlings are notorious nest robbers. The two most practical control methods are covering crevices and cracks in eaves around buildings with wire screen and feeding only oil-seed sunflower and millet. Suet put out for other birds will attract these species, especially starlings. Starlings won't nest in boxes with shiny walls, so you might consider placing a sheet of tin or aluminum foil on one wall of your bird houses.

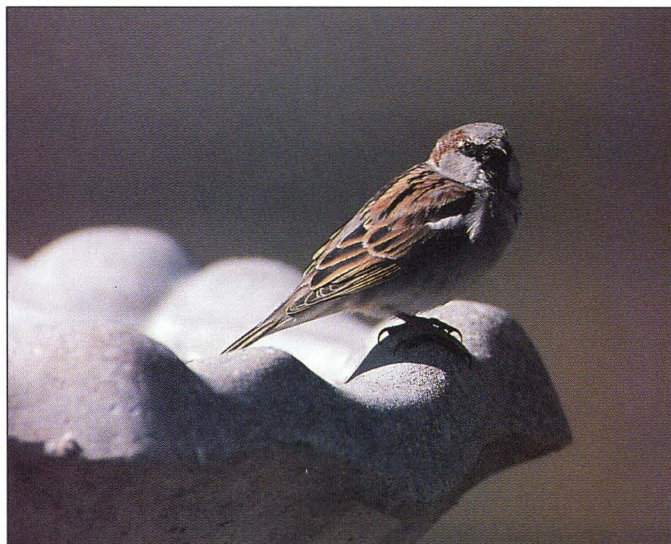

### Rabbits

When vegetables disappear from the garden, the images of Bugs Bunny and Peter Cottontail come to mind immediately. Often, cottontails are the culprits, but sometimes they play scapegoat for ground squirrels, wood rats, crows, and even worms. Check the site of damage carefully for tracks and droppings before passing judgement. If you want a few rabbits around but not in your garden, plant lure crops such as clover and alfalfa in a far corner of your yard. Rabbits will also eat dandelions, which is an added benefit of having them around. Keep brush far from the garden. A tight, two or three-foot fence will keep them out.



### Squirrels

Squirrels can be a nuisance to some people, especially when they invade bird feeders. However, a number of squirrel guards are available to deal with this problem.





# In the eye of the beholder

Suburban lots edged with oak, dogwood, and fragrant sumac and highlighted with varying heights of native grass have become more and more common in recent years. They reflect a growing awareness of the natural environment and an increasing conservation ethic, especially in regard to the use of water. They also reflect emerging aesthetic values that emphasize the natural landscape over the well-groomed lawn.

Still, a lawn landscaped for wildlife is not for everyone. Some folks may even object to their neighbor's taste in landscaping, particularly if what he perceives as "weeds" are allowed to grow. In some cases, local laws may even get into the act.

In the early '70s, a suburban Milwaukee woman planted backyard habitat only to find herself at odds with local maintenance workers and a city ordinance against "weeds." The workers mowed the woman's lawn without her permission, and she threatened to sue unless they could prove the lawn contained noxious weeds. They couldn't, and had to make an out-of-court settlement with the woman.

Similar challenges have sprung up all over the country since that time. Most city governments have adopted anti-weed ordinances, forcing some amateur wildlife managers to defend their actions. These laws may simply cover noxious weeds as defined by state law, or they can go further. Brush or woody vines may be considered weeds. Native grass or other plants may be considered a fire hazard,



and some plants may be claimed to harbor rats and mice. In cities where such ordinances exist, landowners may be forced to mow some of their plantings. However, some cases have been challenged in court with the local authorities being overruled, and some states have passed laws giving homeowners broad discretion in landscaping decisions.

Until similar action is taken in Kansas, there are a few things you can do to reduce the chances of a legal challenge to your wildlife habitat efforts.

First, avoid those plants classified by state law as noxious weeds. Currently, those are beefy spurge, bur ragweed, Canada thistle, field bindweed, hoary cress, Johnsongrass, kudzu, musk thistle, pignut, and Russian thistle. Under the law, counties have the option to include a few other species in the list, so check with your county extension agent before planting.

For most amateur landscapers with a few patches of native flowers and a shrub or two, the question of weed control will never arise. However, those who simply want to turn their yard over to Mother Nature may have problems. Design is the key. Map your yard and research the values of the plants you want to establish. If design and organization are apparent, you will likely prevail against any challenges to your sanctuary.

Perhaps most importantly, involve your neighbors. If you think they might object, or if they do, explain what you are doing, how it benefits wildlife and conserves water, and how your neighbor will have increased wildlife viewing opportunities as a result of your efforts. Explain to them the specific benefit of individual plantings and invite them over for a winter's backyard bird watch.



# Gallery

by Mike Blair

## Clouds



55mm lens, f/6.7 @ 1/500



400mm lens, f/11 @ 1/250

55mm lens, f/11 @ 1/30





*See the best of Kansas wildlife and wild places*

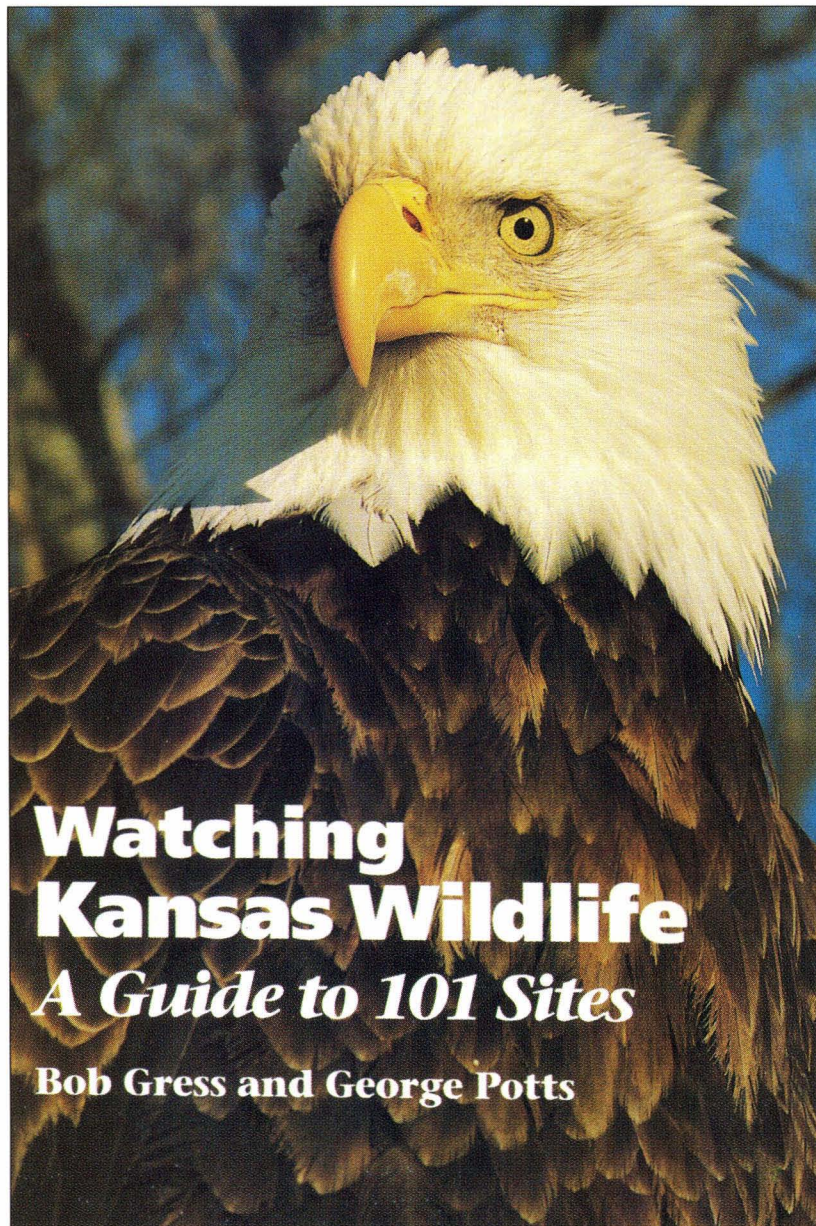

**Watching  
Kansas Wildlife**  
*A Guide to 101 Sites*

**Bob Gress and George Potts**

*Get your "Watching Kansas Wildlife" guide today! Send a check or money order for \$10 plus \$2.90 postage and handling to Kansas Wildlife and Parks, Wildlife Watch, 512 S.E. 25th Ave., Pratt, KS 67124. Mastercard or Visa accepted. Call (316)672-5911 Mon.-Fri.*



Edited by Mark Shoup

### SAILOR'S REVERIE

Editor:

I always enjoyed reading my dad's subscription to your magazine, but then I joined the Navy and moved out of Kansas. Once again, my dad got me back to reading it when he bought me a subscription a few years back.

Even though I've been stationed on the west and now the east coasts, I never felt I truly left Kansas and my boyhood memories, thanks to your magazine. I'm currently on 6-month deployment, and I can't tell you how much I enjoyed your July/August 1993 issue. For awhile, I could set back and forget my work and separation from family, and remember all the good times I had with my brother and friends while growing up fishing and hunting around Andale.

Thanks for bringing back some great memories.

LCDR Ron Yakshaw  
Fleet Surgical Team

### SPAWN WALLEYE HARVEST

Editor:

I just finished reading cover to back the July/August issue of KANSAS WILDLIFE AND PARKS. This is my favorite publication, and I really look forward to my next copy.

I read the article about catching the spawning walleye (Page 38). I don't blame the fisherman for keeping walleye full of eggs that are running out of the fish, but I wonder if he perhaps took about 50 more walleye from the lake by doing so.

I believe we need to protect our spawning walleye just like we have a closed season on nesting quail and pheasants. It seems we spend a lot of money, time and effort raising walleye fry to stock lakes, but we let fishermen

take spawning walleye. Who would think of shooting a nesting pheasant?

Ed Fisher  
Topeka

Dear Mr. Fischer,

**You make a good point, but when you think about it, keeping a fish in March is really no different than keeping one in October. Neither will spawn again. The only way to ensure maximum reproductive potential is to practice catch and release fishing all year. However, most fishermen like to keep a few walleye to eat. That's why we have length and creel limits. And those limits work as much during the spawn as they do the rest of the year.**

**Our creel surveys and walleye anglers' diary survey show that a very small percentage of the total catch of walleye occurs during the spawn. Environmental conditions during the spawn are probably more important than the numbers of brood fish present.**

**A variety of factors determine walleye numbers in a given lake, including suitable habitat, water condition, water levels (especially in spring), forage availability and fishing pressure. District biologists consider all of these, along with spring and fall sampling data to determine the condition of a population.**

**Even when conditions are excellent, only a very small percentage of naturally-spawned eggs will survive to adult walleye. Our hatcheries, however, can hatch as many as 60 percent to 70 percent of the eggs taken. The resulting fry can then be stocked, or they can be raised to fingerlings or even shorts (7-10 inches) and stocked, increasing the survival rate considerably. This management program can help replace fish removed throughout the year and bolster populations when spawning conditions have been poor. *Miller***

### TOO MUCH HOOK 'N BULLET?

Editor:

Your magazine, I note, is almost entirely devoted to fishing and hunting the wild animals of our beautiful state. I have never seen a poem printed in it. I have travelled over this whole country and have seen some wonderful and beautiful scenes in states east, west, north and south, but when I see that sign that says "Kansas," I know I am home in the greatest state of all.

Jo Garnett  
Overland Park

Dear Ms. Garnett:

**I share your affection for Kansas, but I must take exception to your assessment of our magazine. I have received other letters in the past expressing the thought that KANSAS WILDLIFE AND PARKS is "almost entirely devoted to hunting and fishing," so I occasionally cull through back issues to see just how balanced our article selection is.**

**The following list gives you the number of each type of article that has appeared in our magazine since the July/August issue of 1989.**

**Natural History – 46**

**Hunting – 23**

**Fishing – 21**

**Nongame and Miscellaneous  
Projects – 20**

**Habitat Development – 11**

**Parks and Recreation – 9**

**Education – 6**

**Although all of us on the magazine staff hunt and fish, we pride ourselves on providing a diverse selection of topics to our readers. As you can see, natural history – descriptions of the life cycles and habits of specific species or habitat types – has been the predominate topic for the past four and one-half years. –*Shoup***



## TRUTH ABOUT GOATS

Editor:

Your article "At Home On the Range" in the Sept./Oct. issue of KANSAS WILDLIFE AND PARKS (Page 2) is not all good news for the farmers of Hamilton County. The antelope are pretty to view, but the damage they do to our farmland is expensive. The forbs on which they graze are largely bindweed so that in the last 20 years the purchase of chemicals to control bindweed has increased 400 percent. Fighting to control bindweed is an ongoing battle as every year new patches show up in our fields.

There are 945 sections of land in Hamilton County of which the Kansas Department of Wildlife and Parks owns only 484 acres. Why are the rest of us private landowners required to have antelope graze on our crops and do so much destruction? How would it be if we, as farmers, dumped a load of cattle in your backyard? When the antelope graze on the bindweed, the seed passes through their digestive system, and they have been planting this in the soil with their hooves.

You say Wildlife and Parks brought in 100 more antelope to Kansas in 1992. Since this is a state-owned department, I presume that my money goes to help pay for this, and I object.

Mary Gerard  
Syracuse

Dear Ms. Gerard:

**You are not alone in your belief that antelope spread bindweed, but science does not support this theory. Field bindweed is a hearty plant whose seeds can remain viable for 30 years or more, and it has been present in all of Kansas for at least 50 years. However, in 1981 the top three bindweed counties in Kansas (Ellis, McPherson and Marion) had absolutely no antelope.**

**More importantly, fecal samples of pronghorns taken by hunters in 1981 showed no bindweed seed. A Ft. Hays**

State University study of pronghorns the following year came up with the same results – no bindweed seed in the feces of western Kansas pronghorns. In a Colorado study, scientists forced bindweed to pronghorns to see if the seeds could be passed. Of the 2,000 seeds fed, only 369 were passed, and only 25 of those could be germinated in the lab. Of course, this is an artificial situation where the animals are forced to consume bindweed seed. The first two studies I have cited, and subsequent ones, suggest that bindweed simply is not a significant factor in pronghorn diet.

With all due respect, I believe that pronghorns have gotten a bad rap on this issue. Bindweed is an extremely hearty, noxious weed that could be spread from field to field by jackrabbits, birds, tumbleweeds, wind, any number of things you could imagine, including machinery.

Antelope, however convenient a culprit they may seem, should not get the blame for the spread of bindweed. If anything, their contribution is minute.

As far as the antelope introductions are concerned, they were all completed with landowner cooperation and paid for with fees from hunting and fishing licenses, not taxpayer money. —*Shoup*

## WHY A TURKEY?

Editor:

I am writing about wild turkeys. What are their habitats? Where do they roost? What do they eat? How can you tell the tom from the hen?

I have one that has come in my farmyard for the last three weeks. I have a hen house with a scratch pen on the end. I have about 60 bantam chickens. The turkey hangs around the hen house and yard. Do the chickens attract him? The turkey has roosted in the tree above the scratch pen.

Also, should I put up some no hunting signs? What kind?

Delmer Peterson  
Palmer

Dear Mr. Peterson,

Turkey habitat is primarily along riparian areas, or streamsides, but they are also common wherever there are numerous shelterbelts and woodlots. They use trees for cover and roosting – they fly to roost in tall trees every night – and in some cases for food, if the trees produce nuts. Besides nuts, turkeys eat weed seed, grain and, especially in summer, insects.

Toms can be distinguished from hens in several ways. Mature toms have a beard (a tuft of specialized "feathers" that looks like stiff black hair) protruding from the chest. Hens do not ordinarily have beards. The tips of a tom's chest and body feathers are black, compared the lighter buff color of the tips of hen's feathers. Toms are usually larger. Both toms and hens have a snood (a red fingerlike protrusion on top of the head), a wattle (a flap of red skin stretching from the base of the beak to the base of the neck), and caruncles (fleshy, knoblike growths on the neck). However, on toms the snood becomes engorged during mating rituals, and the caruncles are usually larger. During the spring mating season, usually from mid-March through mid-May, the males will spread their wings and tail feathers, puff themselves up, and strut to attract the attention of females.

I can't say exactly why the turkey has come around your place, but I'd say it was because its safe and there's plenty of food around. If you have domestic turkeys, that might attract wild ones, as well.

No one has the right to come on your property without your permission, but if you want to cover your bases, put "Hunting By Written Permission Only" signs up. This not only serves as a warning, it gives Wildlife and Parks conservation officers to right to check licenses on your property anytime, unaccompanied by you.—*Shoup*





## Jail Bait

In an effort to stop the illegal commercialization of wildlife, law enforcement officials with the

and a \$500 fine.

The seven were convicted of the charges in Reno County District Court. One of the group had been convicted of

## FISH POACHERS NETTED

Department of Wildlife and Parks arrested seven Wichita men last September at Cheney Reservoir. The group was using homemade gill nets, setting them at night and removing fish under cover of darkness. Game fish taken included crappie, white bass, striped bass, wiper, walleye and channel catfish.

Department officers charged the individuals with a Class C misdemeanor, which carries a maximum penalty of 30 days in jail

the same violation in March of 1992 and fined \$100; he spent 30 days in jail for the latest conviction. Another man was sentenced to six months probation and fined \$200. The other five were fined \$200 each, and all boats and equipment used in the illegal activity were confiscated.

"I think these convictions send a message to poachers that some judges are tired of the same people showing up for wildlife violations," said Charlie Schmidtberger, acting regional law enforcement supervisor at the time. "Thirty days in jail might remind a lot of people that wildlife laws are in place for a reason — to protect the resource." — Murrell

## DEER POACHER

On Nov. 2, 1993, a Jefferson County man was arrested in Lawrence after conservation officers received a complaint from a landowner who witnessed the subject shoot a deer on his (the landowner's) property and then leave the area.

As the landowner was phoning a report of the violation to CO Glenn Cannizzaro, Tonganoxie, the suspect returned with a friend who helped him load the deer. The landowner was then able to get a better description of the suspect and the vehicle.

While CO Ray Beisel, Oskaloosa, gathered evidence at the scene of the crime, Cannizzaro and CO Clyde Umscheid, Perry, along with two Kansas Highway Patrol troopers, found the vehicle parked at a residence in Lawrence with the deer still in the bed of the truck. The subject was arrested and

booked into Douglas County Jail for illegal possession of deer. —Rob Ladner, assistant regional law enforcement supervisor, Topeka

## EARLY PHEASANTS COST DEERLY

Before the season opener in 1991, a Salina man decided to get a jump on pheasant hunting east of town when he flushed an unexpected bonus — a white-tail button buck. Apparently, the man decided that deer were no more illegal than pheasants, and he shot the buck.

While the man was suspected of the crime, he wasn't caught until the summer of 1993 when he was arrested on armed robbery charges.

For the wildlife violations, the man was fined \$500 plus court costs and given 30 days in jail. He also had to forfeit

his 1100 Remington shotgun. —Shoup

## UPLAND OPENING NOTES

With the opening of quail season, the Law Enforcement Division coordinated two game check stations in Kansas. Regions 1 and 2 jointly operated a game check station on Highway 135 in Ottawa County, where 22 conservation officers, seven Parks and Public Lands staff and one biologist manned the detail. Thirteen college students from Fort Hays State University maintained records.

The group checked 293 vehicles and 669 hunters and issued 22 notices to appear, for a violation rate of 3.4 percent. The most numerous violations were related to pheasants, such as possession of hens or failure to leave

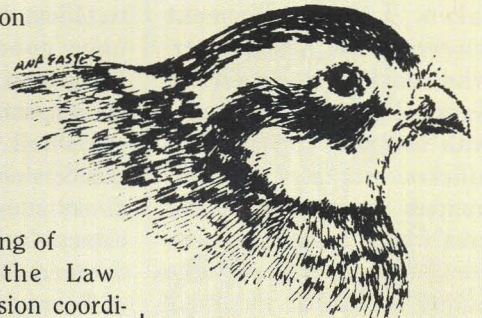

parts attached to identify sex.

The Kansas Highway Patrol assisted with traffic control.

Regions 4 and 5 operated a game check station near Florence at the junction of highways 77 and 50, where 11 conservation officers and two biologists handled duties. Traffic control and violations were handled by the Highway Patrol and local sheriffs' departments. Fifty-three vehicles were checked, and three notices to appear were issued. —Marc Johnson, chief of staff, Law Enforcement Division



## SMOOTH SEASON, FALSE RUMORS

The first Kansas sandhill crane season in modern times opened the weekend of Nov. 6, and the Kansas Department of Wildlife and Parks reports that both hunters and wildlife managers were pleased with the opener. In Stafford County, an estimated 50,000 sandhills were using Quivira National Wildlife Refuge. While no crane hunting was allowed on the refuge, hunters did quite well on nearby areas in the county.

Based on random checks of hunters by conservation officers and biologists, an estimated 100-150 birds were taken. Law enforcement supervisor Jim Kellenberger, who worked the opening weekend in Stafford County with two area conservation officers, estimates that 100 hunters actively hunted the area where the cranes were concentrated. He estimates hunter success at about 1.3 cranes per hunter of those he checked.

"The conservation officers and I were very pleased with hunter conduct," he says. "There was no evidence of unethical activity, and all hunters contacted were highly appreciative of the opportunity to hunt sandhills. I also received positive comments from three landowners who had suffered depredation of green wheat and who thought the season would move the birds around and cut their losses."

To help ensure that hunters would be well-informed and conduct a

responsible hunt, Wildlife and Parks had held three informative "Crane Nights" prior to the season. The information sessions were held in Hutchinson, Great Bend and Dodge City, all towns within the crane hunting unit. Each session included a review of cranes from a management and population perspective, regulations from a federal view, state regulations, areas open, crane hunting techniques, Audubon perspective, permit sales, and an open forum for questions and answers.

State waterfowl biologist Marvin Kraft, Emporia, was also happy with the season opener, both biologically and aesthetically.

"I just don't think it could have gone much better," Kraft notes. "We had a good harvest, and the hunters were disciplined. But just the sheer numbers of birds in the air — ducks and geese as well as cranes — made it worth being out there. It was impressive."

Fears for the whooping cranes had been fanned earlier by national news reports of a whooping crane in Texas that had supposedly been shot. However, the U.S. Fish and Wildlife Service determined that the bird had hit a power line, proving the reports false.

On Friday, Nov. 8, the Quivira whoopers left with a cold north wind, and the first Kansas hunt proceeded without incident. —*Shoup*

## CHICKADEE CHECKOFF TIME

The Chickadee Checkoff is a voluntary donation program. It doesn't receive a lot

of money, but we think we do a lot with the precious dollars you give. We hope you are proud of programs such as OWLS and the wildlife viewing guide, "Watching Kansas Wildlife." Other projects include the Kansas Breeding Bird Atlas, which has involved more than 100 dedicated volunteer birders. The ongoing golden eagle reintroduction program at Wilson Reservoir is one of our showcase efforts designed to not only help golden eagles re-establish nesting in the north central part of Kansas, but also advertize for the Chickadee Checkoff.

Some Chickadee Checkoff funds have gone to research projects in southeast Kansas to determine why some freshwater clams and Neosho mad-toms in those rivers are dwindling. We also have a project in western Kansas to re-introduce the western green toad, a Kansas threatened species, to an area of its former range in the Cimarron National Grasslands of Morton County.

All in all, there is a lot going on for a relatively small \$150,000 or so per year in Checkoff contributions. We sincerely hope you appreciate our efforts for wildlife and hope you continue to give us your precious support. —*Ken Brunson, nongame coordinator*

## BILL WOULD CUT CONSERVATION FUNDS

A bill currently being considered by the U.S. Senate would essentially divert money from state conservation programs to cover provi-

sions of firearms legislation, according to information from the U.S. Fish and Wildlife Service (USFWS). If passed, the new law would cost Kansas nearly \$1 million a year in money earmarked for wildlife conservation projects.

S. 868, also known as the Firearms Victims Prevention Act, would amend the Internal Revenue Code of 1986 to increase the tax on handguns and assault weapons, increase the license application fee for gun dealers, and use tax proceeds to pay for medical care for gunshot victims.

According to Lee Miles, the USFWS's deputy assistant regional director for federal aid, the proposed legislation would have the following effects:

- repeal the current Wildlife Restoration Tax (commonly known as Pittman-Robertson, or P-R) on handguns, firearms defined in legislation as assault weapons, and ammunition used in handguns and assault weapons;

- replace the P-R tax with a 25 percent tax on these items, as well as magazines, clips and strips holding 15 or more cartridges;

- deposit the money collected into a trust fund within the Treasury Department known as the Health Care Trust Fund and make the funds available to hospitals and trauma units meeting eligibility requirements; and

- provide legal descriptions for handguns and assault weapons and increase the application fee for a federal firearms permit from \$25 to \$2,500.



P-R money helps fund nearly every game management program in the country. In Kansas, P-R funds have contributed to nongame habitat and population surveys, creation of backyard habitat, habitat demonstration projects and numerous prairie restoration projects. —Shoup

## Book Beat

### OVER THE RAINBOW

How many times have you heard the old saw, "Kansas is flat as a pancake. There's nothing there. It's just a boring stretch of road between Kansas City and the mountains.?" Unfortunately, all too many Kansans buy into this misconception.

For those who know otherwise, or those who wish to be convinced, *Kansas On My Mind* is the next best thing to being there. This lovely coffee table book is introduced by Steve Harper and features the work of some of the Midwest's finest nature photographers, including Mike Blair, Bob Gress, Daniel Dancer, Steve Harper, Frank Oberle, and Gerald Wiens.

This is a photo essay that will make you want to get out and really see Kansas, in all its splendor. You'll see wildflowers in the Red Hills and Flint Hills, High Plains bluffs in the northwest, lush river bottoms in the southeast, and prairie fires that once shaped this immense land. Prairie dogs, prairie chickens, raccoons, deer, songbirds and luna moths are among the many wildlife species captured.

The human landscape also figures prominently in *On My Mind*. Cannons off the bridge at the Wichita River Festival, a barn dance near Salina, wheat harvest near Winfield, Native American celebrations,

and children playing beneath the impending swell of a thunderstorm — all these scenes dance across the pages.

Anyone who loves Kansas and loves good photography should have a copy of *Kansas On My Mind*. Published by Falcon Press, P.O. Box 1718, Helena, MT 59624, this one should be available in Kansas bookstores for some time. —Shoup

### TALES OF CHANGE

*Tales Of the Earth*, by Charles Officer and Jake Page, outlines the history of natural disasters around the world and their effect on human populations. One of the most dramatic descriptions is of the 1815 eruption of the volcano called Tambora, in the south Pacific. A year later, this explosion cause brown, blue and even red snow in Maryland. Crops failed throughout America, and in Europe a major disaster ensued with food riots and famine. Volcanoes, earthquakes, floods, comets and meteors, ice ages and epidemics are all covered in an enlightening combination of scientific and historical thoroughness. The final three chapters of the book reverse the focus and cover the effects of mankind on the environment

*Tales of the Earth* is not for everyone, but it is filled with enlightening explana-

tions of its scientific subjects, in language easily accessible to the layman. I particularly enjoyed the blend of history and science. *Tales* is published by Oxford University Press, 200 Madison Avenue, New York, NY 10016. —Shoup

### COLOR ME WILD

Last fall, the National Wildlife Federation and the National Audubon Society jointly sponsored two books with great promise for children. *Insects* and *Deserts* are published by Houghton Mifflin under the Peterson Field Guide Coloring book series. Each contains sixty-some pages of biologically accurate — but uncolored — drawings of insects and, in *Deserts*, a variety of desert critters.

The front and back pages of each book contain beautifully-illustrated, full-color drawings of all species in the book, complete with a number code for quick reference. In addition, each drawing is accompanied by text describing behavior and habitat of the species to be colored. The result is an excellent educational tool and identification guide that should be great fun for any budding naturalist.

These two excellent books should be available at local bookstores. They are published by Houghton Mifflin, 222 Berkeley Street, Boston, MA 02116. —Shoup

### 'ROOMS GALORE

Whether you're a seasoned mycologist or a novice mushroom hunter, *A Guide to Kansas Mushrooms* is the book for you. Written by

Bruce Horn, Richard Kay, and Dean Abel, and published by the University Press of Kansas, this new field guide is by most accounts one of the best of its kind in the U.S.

One of the book's most striking features is the photography, which includes excellent color views of 150 species. Some of the more difficult to identify or more dangerous species have photographs showing various stages of development.

However, the book is more than pretty pictures. Although species are listed by scientific name, the common



names of each species are well-indexed. The book is written in clear, easy-flowing prose and includes a lengthy discussion of edible and poisonous mushrooms. A calendar of fungal fruiting seasons will help the gourmet mushroom hunter.

*A Guide to Kansas Mushrooms* is available in bookstores or may be ordered direct from the University Press of Kansas, 2501 West 15th St., Lawrence, KS 66049. —Shoup



## CABIN FEVER SURE CURE

**M**uch has been written about the dreaded cabin fever. It's an affliction fishermen suffer through the winter months, while they wait for the spring thaw and a dose of fishing to cure them. Many false cures have been proclaimed, such as cleaning your reels, building a rod from scratch or sharpening your hooks. These aren't really cures but only medications that temporarily hide the fever's symptoms. There is only one cure, and it's quick and easy - winter fishing.

I know what you're thinking, as you shiver uncontrollably, this cure involves ice, insulated coveralls, silly little rods, ice augers and frost bite. But you're wrong. You can fish in the dead of winter, and when conditions are right, you'll catch fish. For successful winter fishing you need three things: 1) a day nice enough for you to enjoy being outdoors (this varies with individual tolerance for cold); 2) open water; and 3) some tiny lures and an ultralight spinning outfit.

Kansas is famous for those beautiful late-winter days when the temperature soars above normal and the sun shines. There's nothing like warming water to get fish in an active mood.

Open water can be easy to find during one of our mild winters, but if the weather has been frigid, it can be difficult. Look for spring-fed ponds and spillways at reservoirs where water is being released. In eastern Kansas, you can always go to La Cygne Reservoir, a generating reservoir with warm water year-round.

Spring-fed ponds can be good if the majority of the pond is ice-free. Approach the water carefully; late-winter ponds can be gin clear, and fish will be easy to scare. Cast tiny jigs on light line and retrieve them slowly. In fact, if you can fish out of a boat and hold the lures still, you'll probably catch more fish. Jig vertically, keeping the jig suspended for seconds at a time. If you're fishing from the shore, use a bobber to suspend the jig. Often, wave action on the bobber will be enough to entice strikes. This can be a great way to catch winter crappie. Fish near some kind of structure like submerged brush, a sharp dropoff or a dock.

At a reservoir, the spillways will nearly always provide open water. The best fishing, however, will be at those that are releasing water. The moving water is generally warmer, oxygen-rich and probably provides a good food supply. Again, cast tiny jigs and lures, and retrieve them as slowly as you can. Maintain contact with the line and use a sensitive rod because strikes will be barely perceptible. Wintertime spillways can be great places to catch white bass, crappie and occasionally walleye. Some have winter trout programs where trout are stocked periodically through the winter to provide an additional fishing opportunity. Check with the Wildlife and Parks office nearest you for trout stocking locations, and purchase any required trout permit before you fish one of these spots.

During the unusually mild Kansas winter, some dynamite

winter fishing can be done at many reservoirs across the state, but you need a boat and some kind of locating sonar. Wintertime is crappie time, especially in northeastern Kansas reservoirs. Huge schools of crappie will congregate over creek channels, submerged islands, old tree stumps or road beds. Boaters who find these fish can anchor over them and fish jigs and spoons vertically. Once fish are found, finding the right depth is the key, but after that the fishing can be phenomenal. Be sure to check local reservoir regulations; some lakes have a 10-inch minimum length limit. The statewide creel limit on crappie is 50.

Fishing is the only way to cure cabin fever, and it can be productive when you put together all the pieces of the cold-water fishing puzzle. Don't sit around and feel sorry for yourself any longer. Get out and catch some fish. —Miller

## STAY DRY, WARM

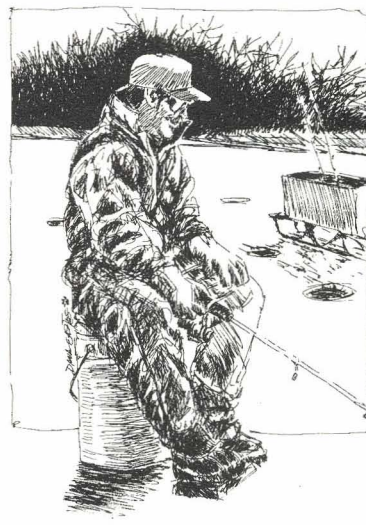

**A**vid winter- and early-spring anglers have one important consideration beyond a good creel - avoiding the water and staying dry. This is particularly important for boaters, who are at greatest risk of falling in the water. Cold winter water can shock the system and quickly cause hypothermia, a real threat to human survival. Even 40-50-degree water can kill.

Obviously, the best way to avoid

hypothermia is to stay out of the water. This requires extra caution when water is cold. However, if you happen to capsize your boat or fall in the water, a few rules of thumb can help you survive.

If you can't get out of the water quickly, floating is the first course of action. Curl up in a ball by crossing your arms over your chest and bringing your legs up into the fetal position. This not only helps you float, it conserves heat. Keep floating until you can be rescued, and do not swim to keep warm because this will simply burn precious body heat. Don't try to remove clothes or boots because they help keep you warm and afloat. Chances of swimming to safety are slim, so don't try it unless absolutely necessary.

Of course, a personal floatation device will help in your struggle to stay afloat, reducing the amount of energy expended, but caution is the first rule of thumb. Be aware of winter danger and try to avoid it. —Shoup



## BIRD HABITAT HABITS

For anyone willing to brave the cold, winter weather can make pheasant hunting easier, especially if you understand the various habitats and the routines that dictate when pheasants occupy each type of habitat. Essentially, pheasants need four basic types of habitat – roosting, feeding, loafing and,

## Harsh Winter Weather

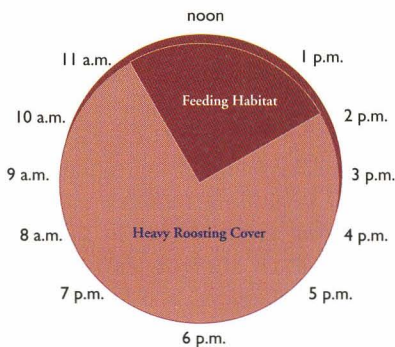

in periods of extreme cold, thicker roosting areas for added shelter.

Typical roosting areas include wheat and cane stubble and native grasses. In colder weather, pheasants seek out heavier vegetation such as switchgrass, which tends to remain upright even in snow and provides a protective canopy. Annual weeds such as kochia (fireweed) and Russian thistle (tumbleweed) also provide cover to block snow and wind.

Everyone knows that milo stubble provides excellent feeding habitat for pheasants, but corn and sunflower are also pheasant favorites. Although wheat provides less energy than these other grains, pheasants will eat it, too.

Between feeding and roosting times, pheasants need relatively safe areas to rest, called loafing areas. Loafing areas allow plenty of warm sunlight while providing some protective cover from raptors. Sandhill plum, smooth sumac, sparse stands of giant ragweed and other tall weeds, openings in cedar stands, and even tree belts can fill this need.

Areas that have all of these habitat types in close proximity should be the most productive, but understanding habitat types is only part of the picture.

To make the most of winter pheasant hunting, you must also know when the birds use what habitat. To a great extent, this is dependent upon the weather. In colder weather for example, the birds will tend to loaf less, feed in the warmest hours of the day, and go to roost earlier. These charts should give you a general

## Mild Winter Weather

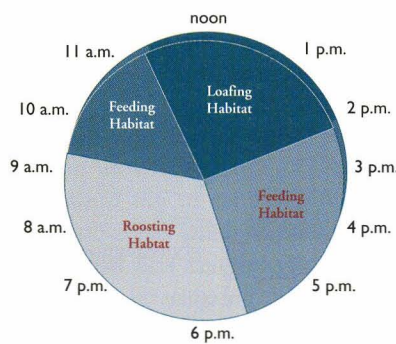

idea of when to expect the birds where. Use this as a guide and you should improve your pheasant bag this winter. Happy hunting. —Shoup

## PEAK OF THE SEASON

The bowl games have been played, and you've eaten too much Christmas turkey. The hunting trips with relatives are over, and there's nothing to do but play checkers and stare out the front window, waiting for the ice to thaw. You feel like you've probably gained 10 pounds, but it's that time of year, right?

Wrong. January may be the best month of the year for Kansas hunters. Although there's still plenty of season left, most of the visiting relatives and other nonresidents have gone home. As a result, competition on both public and private land is greatly reduced.

Cold weather also makes it easier to hunt birds because they tend to hole up and sit tight in heavier cover. If there's snow on the ground, the amount of suitable cover is reduced, making it easier to pick hunting spots.

The choices of game are still good in January, too. Pheasant, quail and prairie chicken seasons all run through Jan. 31,

but upland game are not the only quarry available. Rabbit season runs year round. Dark geese (Canada and whitefront) can be taken through Jan. 30, and light geese (snow, blue, Ross') can be taken through Feb. 13. For the truly adventurous gourmet, crows can be hunted through March 10. The most common furbearers – badger; bobcat; gray, red and swift fox; mink; muskrat; opossum; raccoon; and striped skunk – can be hunted through midnight, Jan. 31. (These species and weasel may also be trapped during the same period. A furharvester license is required to hunt, trap or run furbearers.)

As a matter of convenience, if you hunt early in the year, you won't have to worry about buying license come fall.

All season dates and bag limits can be found in the *1993-94 Kansas Hunting and Furharvesting Summary*, available at all Wildlife and Parks offices and wherever hunting licenses are sold.

The hunting season is far from over. In fact, the best lies ahead, so get up from that couch and burn off some of that dressing and gravy. If you do well, you might not have to eat turkey until Easter. —Shoup

## COYOTE CALIBERS

According to Gene Brehm – Wildlife and Parks' video photographer and seasoned coyote caller – when winter stresses prey species, coy-

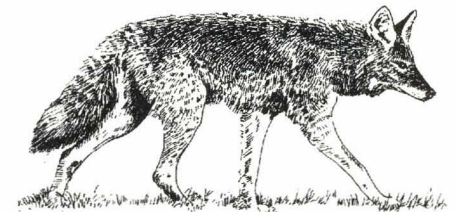

otes respond well to calling in cold weather. But a well-chosen firearm may be the most important consideration if you decide to hunt coyotes in winter.

"Lighter bullets are absolutely essential for safety," says Brehm, "because they won't travel a great distance after hitting the ground. Steel-jacketed bullets tend to reflect easily, but soft-points and bullets of lighter construction are much



better.”

A heavy caliber is not necessary, either. Calibers such as .22-250, .25/06, and .243 are solid, common coyote cartridges.

A scope is also a must, and a good quality sling or a tripod mount will help steady your shot. —*Shoup*

## UPLAND OPEN REPORT

If the snow and rain hadn't moved into the state the second day of the opening weekend of pheasant and quail seasons, it might have been even better. As it was, most bird hunters participating in the opening weekend of Kansas' 1993 pheasant and quail seasons enjoyed fair to good hunting success.

“After the snow and rain moved in, things slowed down on Sunday,” said Jerry Bump, regional law enforcement supervisor for the Kansas Department of Wildlife and Parks. “But the hunters we talked to were very successful in this region.” Bump's officers patrol northwest and northcentral Kansas.

Conservation officers operated a game check station on U.S. 81 north of Salina opening Sunday afternoon and checked 669 hunters who had taken 1,863 pheasants during the opening weekend. “That's real good hunting success considering the weather we had,” Bump said.

Conservation officers around the state reported relatively few violations. “I think we only had three trespassing complaints in my 28 counties,” said Jim Kellenberger, supervisor of law enforcement in the southwest region. He said hunters in his region averaged about a bird per hunter opening day although the number of hunters appeared to be lower than recent years.

Hunters in the northern part of the south-central region averaged about two pheasants per hunter opening day, as well as good numbers of quail, said Val Jansen, law enforcement supervisor based in Valley Center. Elsewhere in her region, she said, hunter success and the number of hunters were substantially lower.

“We had quite a few hunters limit out,” reported Charley Ward, regional law enforcement supervisor for the southeast region. He said the number of hunters out was low due to the inclement weather but that quail hunters, especially in the southern part of the region, were doing well.

It was a relatively safe opening weekend, as well. Six accidents were reported, none resulting in serious injuries. —*Mathews*

## UNDER CURRENTS

# A License To ENJOY



by Gene Brehm

What is the reason that you buy a hunting or fishing license? Is it to give yourself the opportunity to fill your freezer with fish or to shoot that trophy buck? While harvest is certainly a part of both these activities, I'm hoping that your main motivation is just to get outdoors for some high-quality recreation.

Many hunters and fishermen put too much pressure on themselves to bag their quarry. On return from an outing, their friends and relatives invariably ask, “How did you do?” or “What did you get?” The question should be, “Did you have fun?”

Often, our outdoor culture overglorifies the idea of getting a trophy. This places too much emphasis on the prize of the outing and ignores the real heart of the experience. While it isn't wrong to set a goal, it is important to keep perspective.

A good friend of mine bowhunts for a “good” deer each year. One recent season he hunted hard and turned down many opportunities on animals that did not meet his prescribed standards. When the season came to a close, he had to mark his report card, “unsuccessful.” While it's true that he would have liked to have bagged a buck, his endless stories of observing deer behavior prove to me that his license money was well-spent.

Hunting and fishing regulations are fairly liberal in Kansas today. Our upland bird seasons last for three months. The bag limit on pheasants is four, on quail eight, and on prairie chickens two. The possession limit is four times the

daily bag. This affords maximum recreation while still protecting game species. However, a wildlife ethic that emphasizes bagging game above all else can lead to violations of our carefully-planned limits. I once overheard a story of how two “hunters” bragged about bagging twelve giant Canada geese in one day – 12 times their limit at that time. This kind of behavior not only endangers the species hunted, it endangers hunting.

Personal ethics should be a part of every hunter's and every angler's code of behavior. Certainly, the mandatory hunter education classes that beginning hunters attend are making great strides in this direction. Each student learns why we have regulations, and hopefully they all adhere to them.

Some fish species such as crappie are so prolific that only a high creel limit (50) is needed to protect their numbers. However, is it ethical for one fisherman to fill his boat with fish and give those fish away to someone who doesn't buy a fishing license? It is the other license buyers who are paying for the maintenance of our lakes. Why not take what you can use and leave the rest for them?

The behavior of hunters and fishermen will continue to improve as the education of our youth continues to improve. With this, I hope to see more emphasis on enjoying the resources and less on filling bag and creel limits. Our Outdoor Alert Program (1-800-228-4263) has proven that the majority of people afield don't approve of unethical or illegal behavior toward our wildlife. Still, we must all look inside ourselves to determine if we hunt and fish for the right reasons.

As Aldo Leopold said, “There are some who can live without wild things and some who cannot.”

I am convinced that those who hunt and fish cannot.



## WINTER WILDLIFE MESS HALLS

Many Kansans enjoy the pleasures of feeding wild birds, particularly in winter. The wide variety of species wintering in the state provide hours of enjoyment for the household, and feeders are welcome supplements to avian diets. While feeding birds in winter may not be necessary for their survival – birds have survived winter without man's help for millions of years – the educational and entertainment benefits of a backyard bird feeder are undeniable. Probably the best feeder has a large capacity – a gallon or more of seed – and dispenses feed as it is used. It should be placed near trees or bushes that provide cover but not so close as to provide an ambush for marauding cats and other predators. To prevent squirrels from invading the feeder, place a disc-shaped squirrel baffle on the post a few inches below the feeder. A garbage can lid with a hole in the middle will do.

Those who want to feed the squirrels can drive a nail into a tree or post and spear an ear of hard corn onto it. Squirrel feeders designed to accomplish this same feeding opportunity are also sold at hardware and seed stores.

For the beginning wildlife restaurateur, the best overall feed is black-oil sunflower seeds, available at most grain elevators in 50-pound bags. This feed has the advantage of being preferable to the most desirable species, such as native sparrows and finches, chickadees and nuthatches.

Don't forget the insectivores. While most will eat seed from the feeder, they also need animal fat to supplement their winter diets. Suet can be placed in a mesh bag, such as an old grapefruit bag, and hung from a tree. Another method is to drill holes in a log, stuff the suet into the holes and hang the log from a limb. Suet feeders will attract chickadees, nuthatches and woodpeckers.

Once winter has passed, bird lovers don't have to abandon their feeders. They'll attract a different array of bird species year-round. And the benefit is more than aesthetic. Birds will police both backyard and garden, gleaning destructive insects that may otherwise be attacked with pesticides. —Shoup

## THE EAGLE RETURNS

Since the banning of the pesticide DDT and the passage of the Federal Endangered Species Act and the Kansas Nongame and Endangered Species Act, the bald eagle has made a remarkable recovery nationwide. In 1989, Kansas eagles began their share in this recovery by nesting here for the first time during the 20th Century. Two nest sites have produced young each year since.

A nest at Clinton Reservoir has fledged 14 eaglets, and a Hodgeman County nest has fledged 8 young over the last five years. Seven other nests have also been documented, with one – at Hillsdale Reservoir – producing young in 1993. Even more encouraging, the adult female at the Hillsdale site was born in 1989 at Clinton Reservoir.

The nests that did not produce young are typical for first

time nesting bald eagles. Young adults often pair up, build a nest, maybe lay eggs and then abandon the nest. This occurred at sites on Tuttle Creek, Perry and El Dorado reservoirs and on private lands in Scott and Republic counties. On the Flint hills National Wildlife Refuge, a pair nested and sat on infertile eggs for about 45 days before abandoning the nest.

Last year at El Dorado Reservoir, a pair of eagles built a nest in a dead tree approximately 40 feet above the water. In March, the eagles left the nest site, and soon after, a pair of Canada geese found the nest and took up housekeeping.

With an increasing number of established and "practice" nests, Kansans can look forward to a growing population of nesting eagles in the Sunflower State. — Jerry Horak, wildlife researcher, Emporia

## KIDS PUSH STATE AMPHIBIAN

Last spring, a class of second grade stu-

dents at OK Elementary School in Wichita wrote letters to the Wichita area state representatives and senators nominating the barred tiger salamander (*Ambystoma tigrinum mavortium*) as the "declared official state amphibian of Kansas." The legislators were sold on the idea and promised to propose a resolution in the 1993-94 legislative session. However, they said that "for it to pass, girls and boys all over the state need to write letters of support to their representatives and senators."

"We are urging teachers across the state, at all grade levels, to have their students join in the effort," says OK Elementary teacher Alice Potts. "They should learn about the barred tiger salamander and send letters to their legislators asking for their support."

Larry Miller, whose students successfully led the effort to declare the ornate box turtle as the Kansas State Reptile, agrees. "It will take a combined effort of students throughout the state to get the resolution through the legislature."

Teachers can use this as a motivational learning experience. Research and writing and other communication skills can be used to reach a specific goal. Students will also get the chance to see the government process at work.

So why the barred tiger salamander? According to Potts, it is found statewide and is the only salamander found in the western portion of Kansas. Its yellow and black colors are traditional for Kansas. It helps to keep nature in balance by eating lots of insects. Also, the barred tiger salamander is an indicator of pollutants in water because it absorbs pollutants through its skin, thus warning us that something could harm humans.

To get involved in the "B.T. Salamander Campaign," send your letter of support to Alice Potts, Second Grade Teacher, OK Elementary School, 1607 N. West Street, Wichita, KS 67203. —George Potts, Wichita

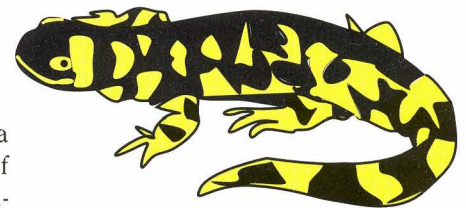



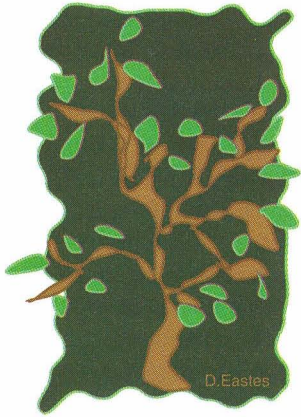

## TREE SEEDLINGS

Is planting some wildlife habitat in an odd corner or in the backyard something you've wanted to do but haven't? What about a woodlot, windbreak, or other conservation planting?

You can get a jump on the tree planting year by ordering trees and shrubs this winter from Kansas State and Extension Forestry. The sooner you apply, the better your chance of getting your selection of plants. The plants will be shipped to you in March and April.

A wide assortment of bare-root trees and shrubs and container-grown plants is available in this, the 38th year that Kansas State and Extension Forestry has offered trees for sale. Thirty-five different kinds of trees and shrubs plus special wildlife and songbird bundles are offered.

The only restriction on the use of these plants is that they can be used only for conservation purposes. There are no restrictions on ownership of the land or rural vs. urban areas. They can't be used for landscaping or resale for landscaping purposes.

Contact Extension

Forestry, 2610 Claflin Road, Manhattan, KS 66502, (913) 637-7050 or see the order form on Page 44.—*Ken Brunson, nongame coordinator, Pratt*

## CHEYENNE BOTTOMS VIDEO

Last issue, we offered the award winning video, *Cheyenne Bottoms: Building For The Future*, for a \$20 donation to the agency, and the response was tremendous. Apparently demand for the video was greater than we expected, so we had to order more. We have a good supply now for anyone wanting this beautiful, informative video.

*Cheyenne Bottoms* details the renovation of Cheyenne Bottoms Wildlife Area, near Great Bend, which is considered one of the most important wetlands in the Western Hemisphere.

The 30-minute program emphasizes the importance of this wetland to both migratory waterfowl and humans and contains spectacular wildlife photography.

Make checks payable to the Kansas Department of Wildlife Parks and mail to Wildlife and Parks, Gene Brehm, Rt. #2, Box 54A, Pratt, KS 67124.—*Shoup*

## OWLS GRANT FROM BOEING

The KANSAS WILDSCAPE Foundation has been awarded a \$10,000 grant from the Boeing Company of Wichita to help develop Outdoor Wildlife Learning Sites (OWLS) at schools in southcentral Kansas.

OWLS are outdoor

learning laboratories established by students and local schools with assistance from the Kansas Department of Wildlife and Parks. The sites offer environmental and wildlife learning opportunities for students in kindergarten through college.

With the Boeing grant, WILDSCAPE has now received \$57,500 for OWLS development in Kansas. Contributors include a U. S. Environmental Protection Agency Environmental Education Grant (\$25,000); a U. S. Forest Service/Kansas State and Extension Forestry Natural Resource Conservation Education Grant (\$10,000); a grant from the Forrest C. Lattner Foundation of Delray Beach, Fla. (\$10,000); a grant from the Price R. and Flora R. Price Foundation of Wichita (\$2,500); and the Boeing contribution.

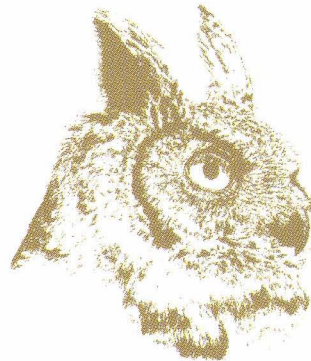

All funds WILDSCAPE raises for OWLS will be matched by the Wildlife and Parks' Chickadee Checkoff program. To date, 34 OWLS have been funded. Approximately 90 more applications have been received.

For more information on the OWLS program, contact Dr. George Potts (316) 943-4134) or any regional office

of the Kansas Department of Wildlife and Parks.—*Mathews*

## ARTIFICIAL LIGHT

Last fall, the Kansas Wildlife and Parks Commission authorized the use of .22 caliber rimfire rifles and pistols while using artificial light to take trapped furbearers and trapped coyotes and for furbearers treed by dogs. The use of artificial light by an individual at night to locate or take wildlife while using a firearm is illegal except as may be authorized by Department of Wildlife and Parks regulation. This exception concerning furbearers was formerly contained in Kansas statutes but was removed by amendment during the 1993 legislative session with the understanding that the issue be treated by regulation.—*Shoup*

## COMMISSION MEETINGS

The Kansas Wildlife and Parks Commission has announced the dates and general locations for its 1994 meetings. They are as follows: Jan. 20, Topeka; March 17, Marysville; April 14, Chanute; June 16, Johnson County; Aug. 18, Emporia; Oct. 20, Wichita; Nov. 17, Dodge City.

If necessary, meetings will start earlier in the day than the usual 1:30 p.m. meeting time. Also, if the need arises, meetings may continue the next day.—*Shoup*

**Rare Bird Hotline sponsored by the Kansas Ornithological Society—913-372-5499.**



# Bob *the shy* cat

## Lynx Rufus



### QUIET BOB

You'll never hear him coming. He appears out of nowhere. That's what most people who spend a lot of time in the outdoors will tell you. Bobcats have terrific senses of sight and hearing. Because of these extra special senses, they are seldom seen, even where they are common residents. They range across Kansas but more are found in the wooded eastern parts of the state.

### THE BOBCAT BOOGIE OR BOBCAT'S BOUNCE BUT THEY DON'T FALL DOWN.

Bobcats sometimes bounce or pounce when hunting small rodents, always landing on their feet because, of course, they're cats. They are very curious and investi-

gate almost everything when traveling their range, which is usually a five square mile area. They walk, trot or take leaps from seven to ten feet at a time. They are also good climbers and take to trees for rest, observation or escape from pursuing dogs. The bobcat is the only native member of the family Felidae still found in Kansas. The bobcat walks on its toes. There are five toes on each front foot. The first is high and does not touch the ground.

**COLOR:** The upper parts of the

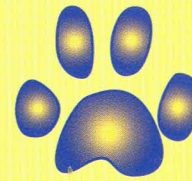

Right Front Foot



Right Hind Foot

body and sides are yellowish to reddish brown streaked and spotted with black. Older bobcats lose their spots.

### GOODNIGHT BOB

Bobcats are mostly nocturnal, meaning they are most active at night.

The bobcat breeds from January to July, but the peak breeding months are February to May. Females may breed twice a year. Litters are born after 63 days, and range from two to seven (usually three) kittens.

### YOU BET YOUR BOBCAT

Even though you may not be lucky enough to see a bobcat in the wild, they are thriving in Kansas. They eat mostly rabbits, rodents, and birds. The abundance of these food sources, the bobcat's small size, and its secretive habits are probably why it is the only feline native thriving in Kansas. The presence of the bobcat in Kansas truly adds the "wild" to the Kansas landscape.









## Charlie Horse and Invisible Tom

It was on an ill-fated spring turkey hunt when I met Charlie Horse and Invisible Tom. Unfortunately, these weren't the ghosts of two Indian legends, but rather the painful and embarrassing result of relying on an unreliable outdoor skill I've worked years to develop.

We hunters revel in our outdoor skills. Reading sign, finding our way, and shooting like Annie Oakley or Howard Hill are sought after skills. We take pride in the old Hank Williams Jr. song "A Country Boy Can Survive." We also believe in the hunters' fraternity — that small group of friends we hunt with. We know each other well, know what the other's going to do before he does it and work together in a pursuit without verbal communication.

What all this really means is that we can tell the difference between a deer track and a coyote track, that we won't get lost in east-west running shelter belt and that we hit the last hedge apple Lennie threw. But hunting together over time really does let you get to know someone. You'll know, for example, that if you haven't seen one partner for several minutes, that he hasn't slipped away to stalk a trophy buck, but is more likely answering a call of nature. Or when he says he'll pick you up at 6 a.m., you don't even consider being ready until 6:20. That's what we call outdoorsman's intuition.

It's an acquired skill that's not always fool-proof, as four fools learned on that spring turkey hunt.

Lennie and I volunteered to let Roy be the shooter, since we'd each filled one of our permits (and besides it was his ranch). Rocky was to capture the awesome display of hunting prowess on video tape. It was an evening hunt so we set up near a likely roost. Even if our supreme calling skills didn't fool a tom, it wouldn't be unusual for one to walk past us anyway.

We soon heard a gobble from the north. We called, it quickly answered, and our confidence swelled. But the gobbles grew faint, then quit. A gobble came from the south. I called. Rocky even called, and Lennie gave his most seductive yelp, but no response was heard. We quit. It gobbled. We called frantically again, but it faded away.

Later, the bird to the north gobbled again, this time closer. We called. It gobbled — much closer. My outdoorsman's intuition told me we'd get this bird. I sensed my partners were thinking the same thing. Lennie and Roy were like statues — camo statues leaning against trees — visions of readiness with only their eyeballs moving.

After a few tense moments, I was sure I heard a bird spit and drum, the sound a tom makes as it puffs its feathers in full strut. A less experienced woodsman might not have recognized this sound, but I knew it was an old tom just as sure as if I'd seen it. Employing my considerable outdoorsman's intuition, I watched my two partners to determine what was happening. You know, I could "see" the action simply by watching Lennie's and Roy's body language.

Then I heard the unseen tom again and saw both hunters tense. Roy even readied his gun. I held absolutely still,

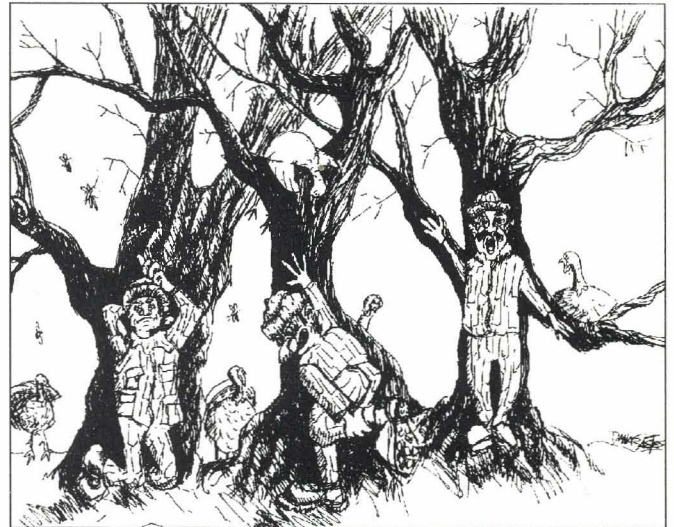

Dana Eastes illustration

knowing that my movement could spook the bird.

I still could not see a bird, obviously because of the brush in front of us. But the others had, I was sure. Then Lennie slowly, painfully, turned to Roy. His eyes, previously squinted with intensity, opened wide in bewilderment. Roy subtly motioned with his hand, low, near his side — another form of unspoken communication. Then Lennie put up one finger, then another. There were two toms! This signal hit Roy like an electric shock, and like a bird dog on point, he slowly moved his head to the stock of his shotgun ready to shoot.

Unfortunately, all this "communication" took place after we'd all been holding absolutely still for 20 minutes, ignoring muscle cramps, sticks poking in tender places and flies buzzing in our ears. Now, after the sign language, we were all convinced that two toms displayed in front and that any movement would ruin the hunt. For what seemed like an hour we endured, then finally broke down.

We rushed . . . er stumbled together to find out what the others had seen. Even the cameraman, who felt a supreme duty to hold still and not ruin the hunt, was walking funny. Legs were cramped and backs were kinked. But when all stories were compared, we had to laugh. Not a hunter had seen a turkey.

Perhaps there was a bird, that all of us heard, but none saw, drumming and strutting in the timber. We'll never know. I know we'll all be less likely to rely on our outdoorsman's intuition again. But perhaps it wasn't our fault at all. It's hard to comprehend that an invisible turkey exists, but it's even harder to believe that such fine-tuned outdoor intuitive instincts could have all failed at the same time. You know, come to think of it, the reality of an invisible tom would certainly explain an awful lot of fouled turkey hunts, when I couldn't possibly have been to blame.





